

5050 Pure Green 30 Degrees Viewing Angle SMD LED with Lens (0.2W)

P/N: LLS5050P6PG-CJ-D30

·Package Dimensions

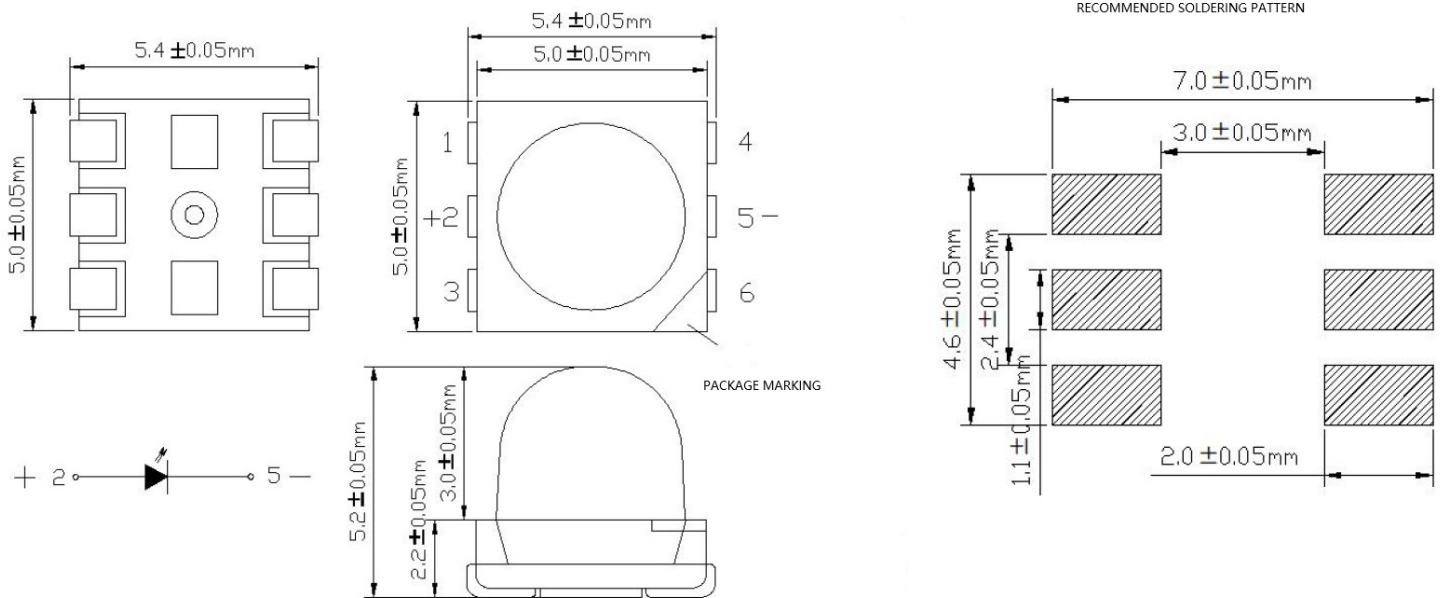

NOTES: All dimensions are in millimeter [unit];

·Features:

- 5.0mm×5.0mm SMT LED,5.2mm thickness
- High reliability, long life
- 0.2W low power LED
- PB Free products (Compliant with EU's RoHS)
- Suitable for all SMT assembly and solder process
- CHIP MATERIALS:
Dice Material: InGaN/AlGaInP
Light Color: Pure Green
Lens Color: Fog colloid
- Moisture sensitivity level: level 5a

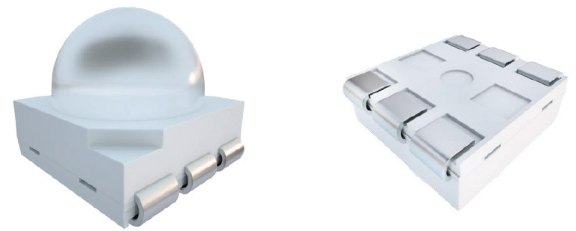

·Application

- Outdoor brightening lighting
- Application of car lights, traffic lights wooden wall screens and pixel screens

·Absolute Maximum Ratings (Ta=25°C)

Item	Symbol	Maximum	Unit
Power Dissipation	Pd	200	mW
Continuous forward current	IF	60	mA
Pulsed Forward Current (1/10 Duty Cycle 0.1ms Pulse Width)	IFP	90	mA
Reverse Voltage	VR	5	V
Electrostatic Discharge (HBM)	ESD	3000	V
Operating Temperature Range	Topr	-40 to +85	°C
Storage Temperature Range	Tstg	-40 to +40	°C
Junction Temperature	Tj	≤125	°C

NOTE:1/10 Duty cycle, 0.1ms pulse width.

·Electrical/Optical Characteristics (Ta=25°C)

Item	Symbol	Condition	Min.	Typ.	Max	Unit
Forward Voltage	VF	IF=60mA	2.8	--	3.4	V
Luminous Intensity	IV	IF=60mA	6000	--	14000	mcd
Dominant Wavelength	λd	IF=60mA	520	--	530	nm
Viewing Angle	2θ1/2		20	--	40	deg
Reverse Current	IR	VR =5V	-	-	10	uA

Note:

- 1/2 is the angle from optical centerline where the luminous intensity is 1/2 the optical centerline value
- The above luminous flux measurement allowance tolerance is ±15%.
- The above Color Rendering Index measurement allowance tolerance is ±2
- The above forward voltage measurement allowance tolerance is ±0.1V

Typical Electro-Optical Characteristics Curves

Forward Voltage VS.Forward Current

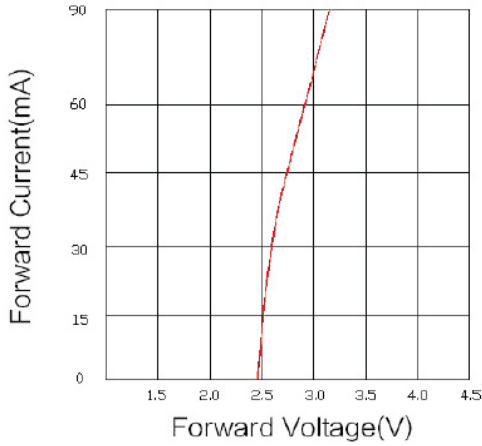

Forward Current VS.Relative Intensity

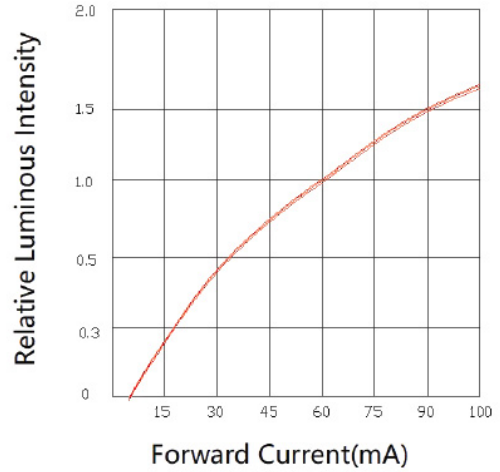

Ambient Temperature VS.Relative Intensity

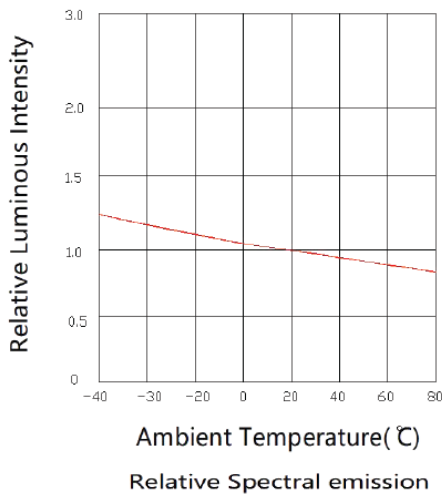

Soldering Temperature VS.Forward Current

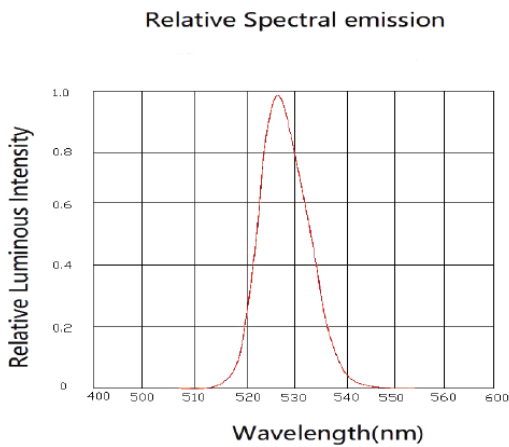
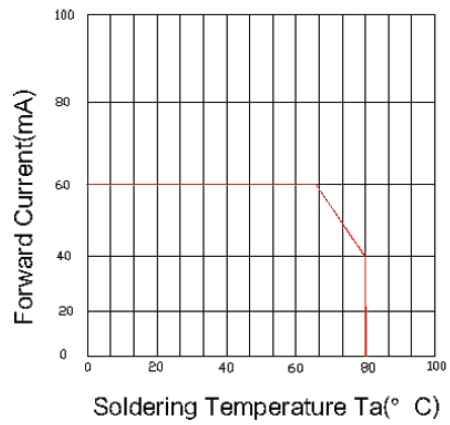

Radiation diagram

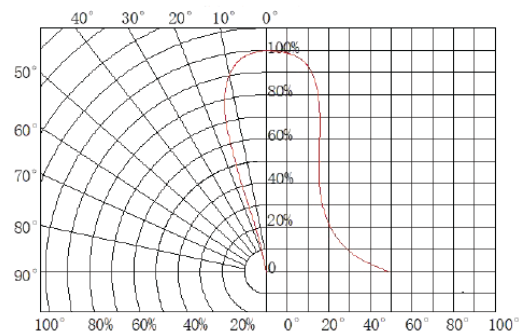

·Reliability test items and conditions

Test Items	Ref. standard	Test Condition	Time	Quantity	Ac/Re
Reflow	IEC/TR 60068-3-12-2014	Temp:260℃ max T=8 sec	3 times	22PCS	0/1
Temperature cycle	IEC60068-2- 14 : 2009	85℃±5℃ 30min ↑↓5 min -40℃±5℃ 30min	100Cycles	22PCS	0/1
High humidity heat life test	IEC60068-2-78: 2001	Ta=85℃ RH=85% IF=60mA	500H	22PCS	0/1
High temperature storage	Tested with LITEKEY standard	Temp:85℃±5℃	1000H	22PCS	0/1
Low temperature storage	IEC60068-2-1: 2007	Temp:-40℃±5℃	1000H	22PCS	0/1
Life test	Tested with LITEKEY standard	Ta=25℃±5℃ IF=60mA	1000H	22PCS	0/1

·Failure Criteria

Test Items	Symbol	Test Condition	Failure criteria	
			Min.	Max.
Forward voltage	VF	IF=60mA	--	U. S. L*) x1. 1
Reverse Current	IR	VR = 5V	--	10uA
Luminous Intensity	Im	IF=60mA	L. S. L*) x0. 7	

U. S.L: Upper Specification Limit

L.S.L: Lower Specification Limit

· Reflow soldering instructions:

1. Number of reflow process shall be only 1 time.

A. Lead Solder:

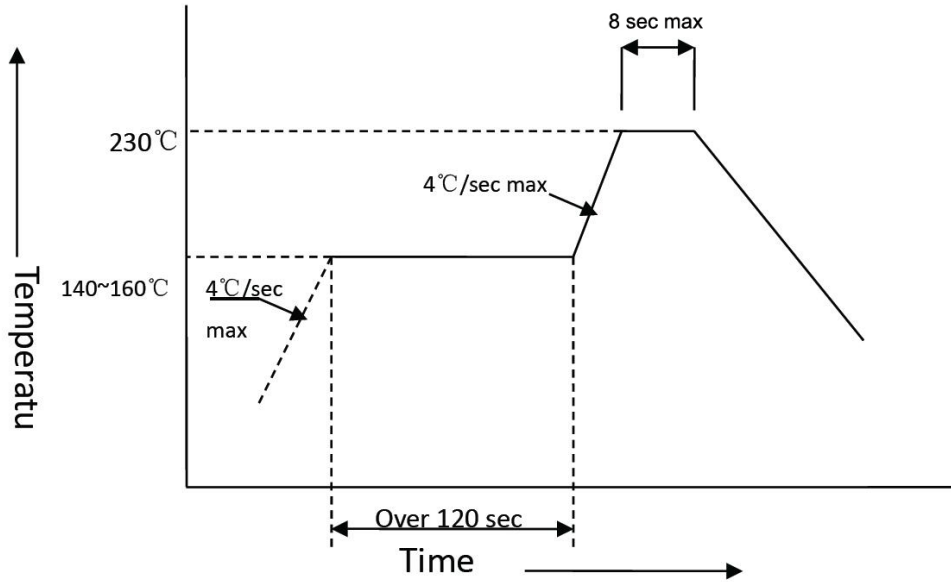

B. Lead-Free Solder:

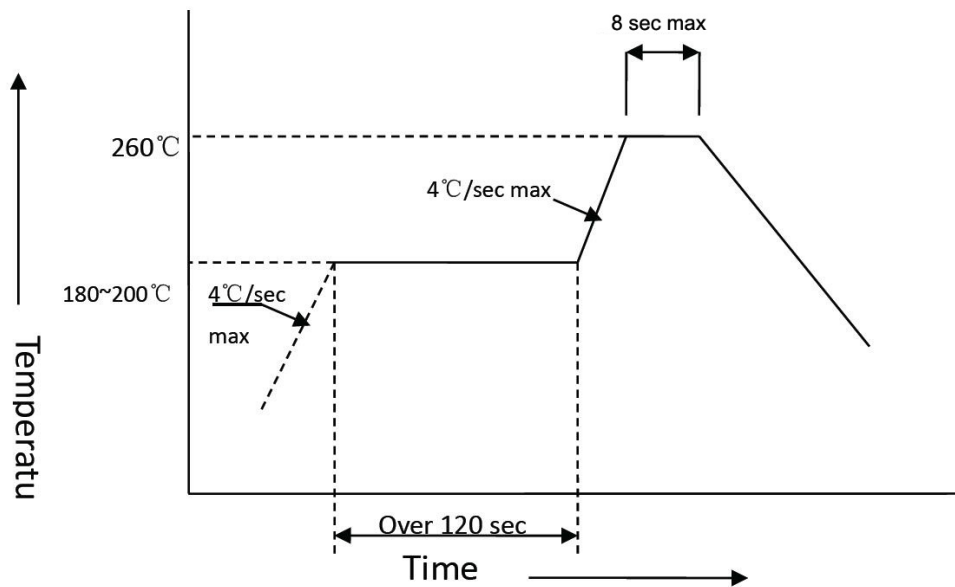

·SMD LED Instruction Manual

Thank you for your trust and support to our company. To enhance your understanding of the product characteristics of our company, it is convenient for you to grasp the characteristics of its use during use, to minimize or avoid unnecessary product damage or performance mismatch caused by human factors. Specifically, as below:

1. Moisture Resistant and vacuum Packaging

All the SMD LEDs are packed in moisture-proof and anti-static aluminum foil bags. During handling, it is necessary to avoid squeezing and puncturing the packaging bags to cause leakage of the moisture-proof bags.

2. Material confirmation

Please check the package for leaks, other damage, and check if the label matches your company's requirements. If you find an abnormality, please contact us in time.

3. Unopened SMD led storage

The unopened SMD led should not be stored for a long time as much as possible, because the storage environment is not easy to control. You can choose a recent delivery based on your production schedules.

The storage environment is best to choose moisture proof cabinet, the temperature is about 30 degrees, the humidity is below 60%, and in this case:

(1) RGB products can be stored for 30 days.

(2) White light products can be stored for 60 days.

(3) 3528 dome series and 3535 RGB moisture proof series can be stored for 2-3 months.

◎ Regardless of whether the storage time is exceeded or not, please be sure to perform the first test before production. If you find an abnormality, please contact us in time.

◎ If the LEDs have not been used in time, it is recommended to use oven baking dehumidification (The dehumidification conditions be adjusted according to products).

4. Precautions after unpacking

After receiving the SMD led from our company, please arrange the production as soon as possible. Due to the different storage environments of each warehouse, it is not recommended to make large quantities of stocks.

After opening the package:

◎ If the package is Intact, it will be better to bake at 70° for 12 hours before reflow soldering process.

◎ It is not recommended to store the SMD led after unpacking. Please accurately calculate the demand for the production line. If storage is required, it is recommended to store in a 60-degree oven.

◎ In the conditions of $25\pm 5^{\circ}\text{C}$ and $45\pm 15\% \text{RH}$, the soldering process must be completed within 12 hours.

◎ If it is not in the range of $25\pm 5^{\circ}\text{C}$ and $45\pm 15\% \text{RH}$, the soldering process must be completed within 6 hours. If not completed, a) unsealing, it is recommended to be stored in the oven at 70-degree low temperature before use; b) vacuum packing, it is best to choose moisture proof cabinet, the temperature is about 30 degrees, the humidity is below 60%.

5. It is not recommended to mix different batches of SMD led

Test before the production according to the first inspection standard. If you find any abnormality in the SMD led, please contact us. Please do not mix different batches of SMD led during the production process. If you can't avoid it, you need to use the LEDs of the previous batch. Please confirm the package is normal, and then confirm the first piece. Finally, the products produced by this batch of SMD led are separately distinguished.

6. In the production process, please fill in the reflow soldering after the patch is completed, **and the reflow soldering is not repeatable.** Reflow soldering. Check the ESD protection measures during soldering and assembly.

7. SMD led for outdoor application, the finished product design is to use a cover lens as much as possible, and then potting seal. It is not recommended to seal directly on the surface of the lamp. The potting glue should try to choose glue with low permeability and oxygen permeability and good adhesion to aluminum. The controller's negative pressure should be minimized.

8. Finished luminaires that have been installed outdoors. If the luminaires cannot be used in time after commissioning, please pay attention to the timing aging. Please use a small current to illuminate all the chips in the early stage of aging. Do not scan the program. After aging for two hours, the current is gradually amplified; do not scan the program, and often aging for 4 hours once a month. In the initial stage of use, please adjust the speed of the controller to the slowest and the color conversion speed is the slowest.

·Other

1. Above specification may be changed without notice. LITEKEY will reserve authority on material change for above specification.
2. When using this product, please observe the absolute maximum ratings and the instructions for using outlined in these specification sheets. LITEKEY assumes no responsibility for any damage resulting from use of the product which does not comply with the absolute maximum ratings and the instructions included in these specification sheets.
3. These specification sheets include materials protected under copyright of LITEKEY. Please don't reproduce cause by anyone to reproduce them without LITEKEY's consent.