

1206 Red Surface Mount LEDs(3216)

P/N:LLS1206SURC

·Package Dimensions

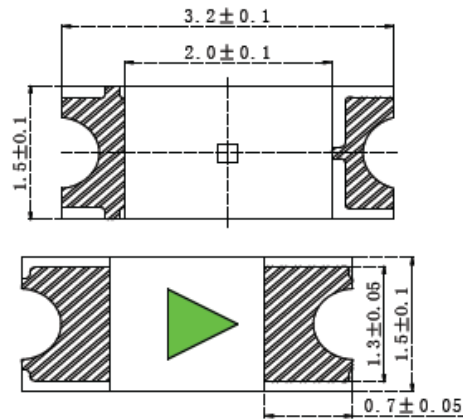
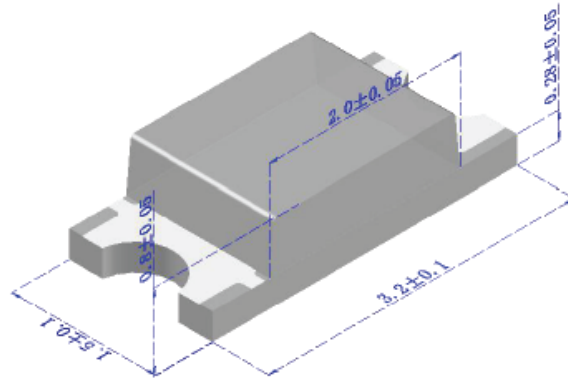

Recommend soldering pad

NOTES:

1. All dimensions are in millimeter [unit];
2. Tolerance is $\pm 0.1\text{mm}$ (0.004") unless other specified;
3. Specifications are subject to change without notice.

·Features

- 3.2*1.6*0.85mm
- Luminous color and colloid: **Red/white colloid**
- Environmental protection products Complied With ROHS Directive
- EIA standard packaging
- Suitable for SMT automatic production
- Suitable for reflow soldering process

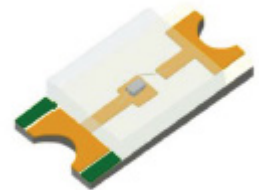

·Application

- Medical equipment: endoscope、oximeter
- Automotive electronics: backlight key light、indicator light
- Industrial products: electronic instrument panel、industrial equipment
- Smart home: white appliances, nixie tube LED
- Communication products: mobile phone button lamp, router

·Absolute Maximum Ratings (Ta=25°C)

Item	Symbol	Maximum	Unit
Power Dissipation	Pd	60	mW
Continuous Forward Current	I _{Fmax}	20	mA
Peak Forward Current (1/10 Duty Cycle 0.1ms Pulse Width)	I _{FP}	60	mA
Reverse Voltage	V _R	8	V
Operating TemperatureRange	T _{opr}	-30 to+85	°C
Storage TemperatureRange	T _{stg}	-40 to+90	°C
Lead Solder Temperature	T _{sol}	260°C for 3 seconds	

·Electrical/Optical Characteristics (Ta=25°C)

Item	Symbol	Condition	Min.	Typ.	Max	Unit
Forward Voltage	V _F	I _F =5mA	1.85	--	2.1	V
Luminous Intensity	I _v	I _F =5mA	32	--	75	mcd
Dominant Wavelength	λ _d	I _F =5mA	617	--	623	nm
Peak wavelength	λ _p	I _F =5mA	--	620	--	nm
Viewing Angle	2θ _{1/2}	I _F =5mA	---	120	---	Deg
Reverse Current	I _R	V _R =5V	---	---	1	uA

·Brightness grading

CODE	MIN	MAX	UNIT	TEST CONDITIONS
M2	32	38	mcd	IF=5mA
M3	38	45		
M4	45	60		
M5	60	75		

·Voltage grading

CODE	MIN	MAX	UNIT	TEST CONDITIONS
V1	1.85	1.90	V	IF=5mA
V2	1.90	1.95		
V3	1.95	2.00		
V4	2.00	2.05		
V5	2.02	2.10		

·Wavelength grading

CODE	MIN	MAX	UNIT	TEST CONDITIONS
R1	617	619	nm	IF=5mA
R2	619	621		
R3	621	623		

Typical Electro-Optical Characteristics Curves

Fig.1 Relative intensity Vs. Wavelength

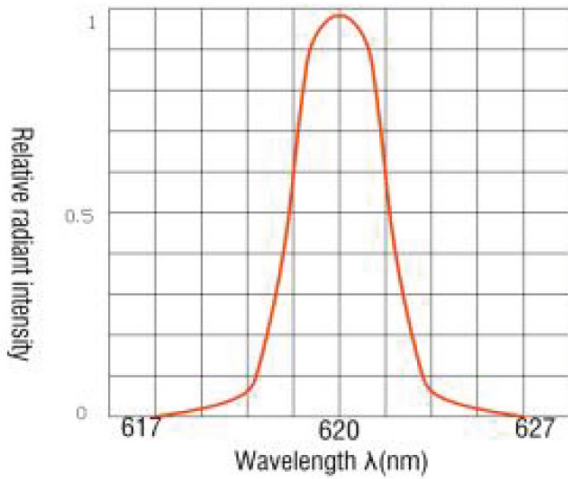

Fig.2 Forward current derating curve Vs. Ambient temperature

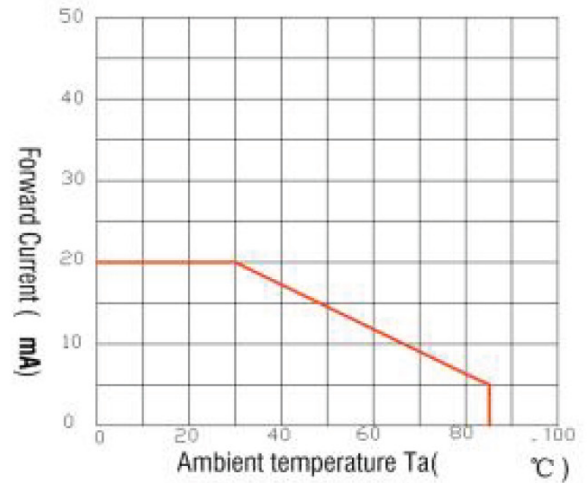

Fig.3 Forward current Vs. Forward voltage

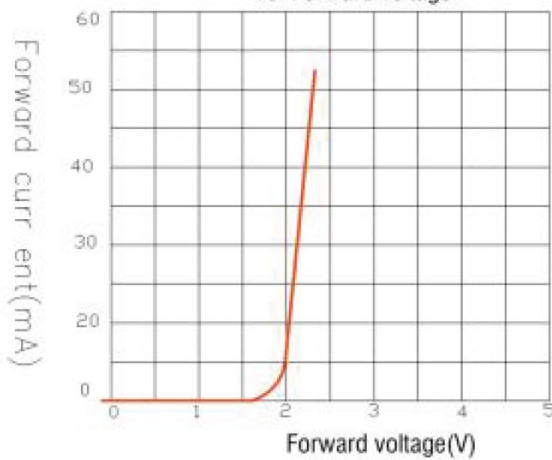

Fig.4 Relative luminous intensity Vs. Ambient temperature

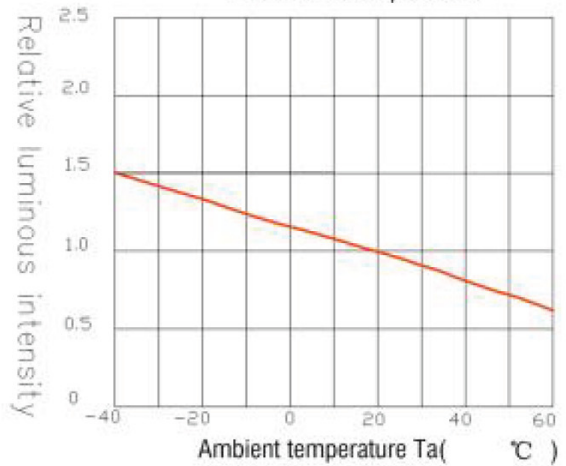

Fig.5 Relative luminous intensity Vs. Forward current

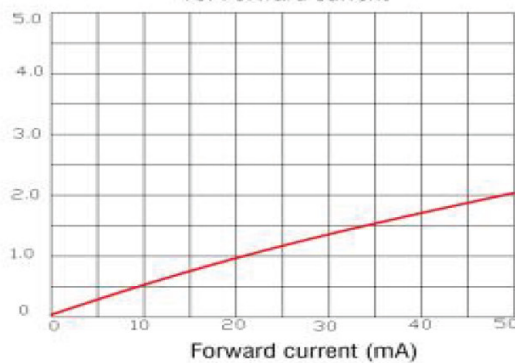
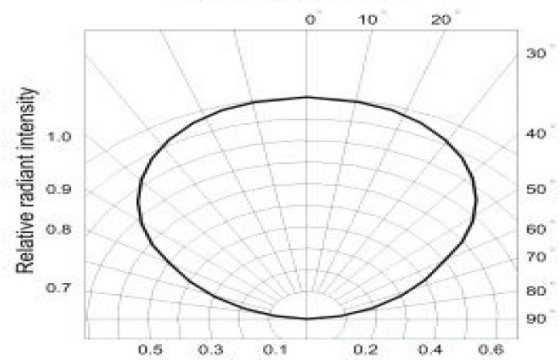
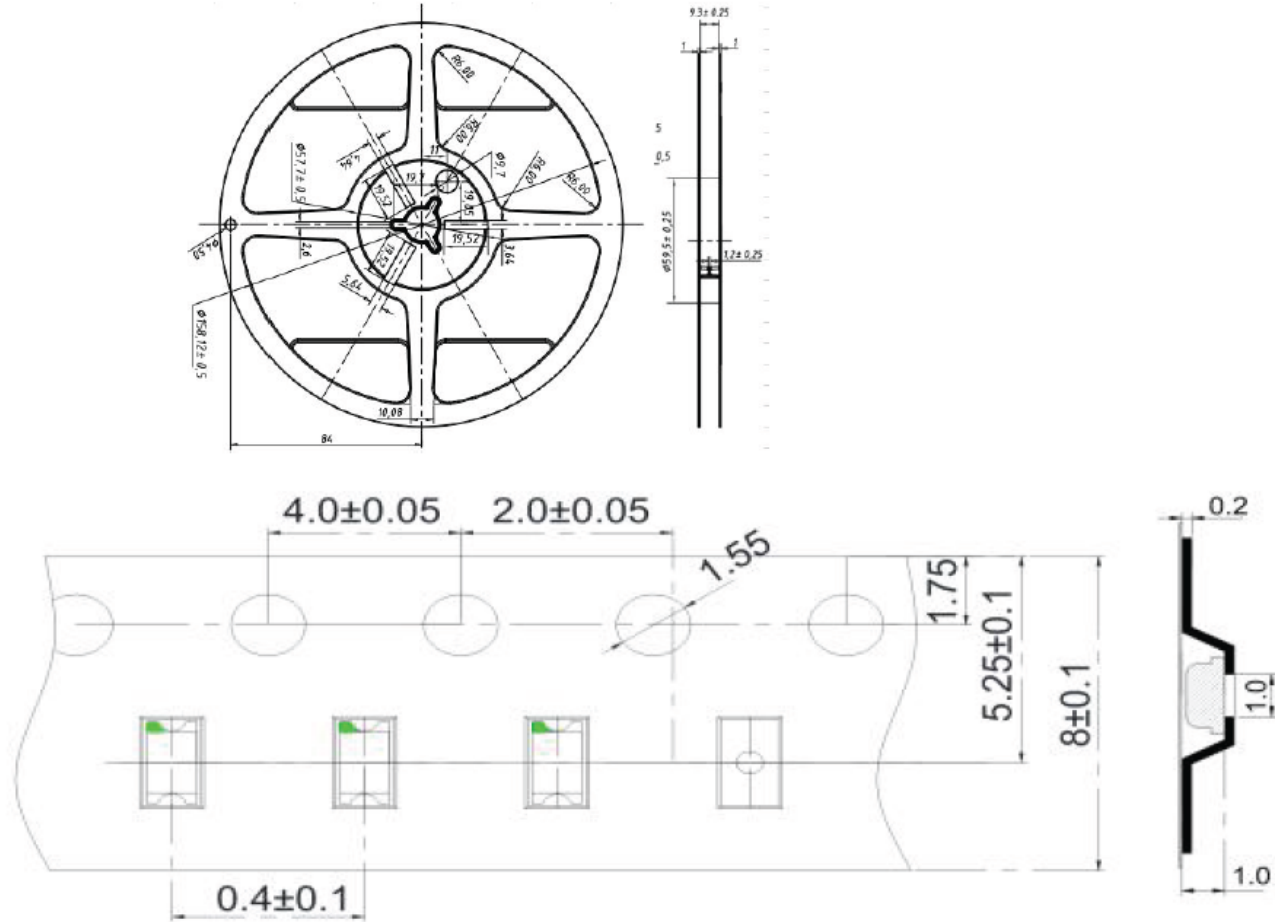

Fig.6 Radiation diagram



•Packaging

Belt and disk dimensions



1. Size unit is mm (mm).
2. The dimensional tolerance is $\pm 0.1\text{mm}$

•Disk and carrier belt direction of roll and hole dimensions

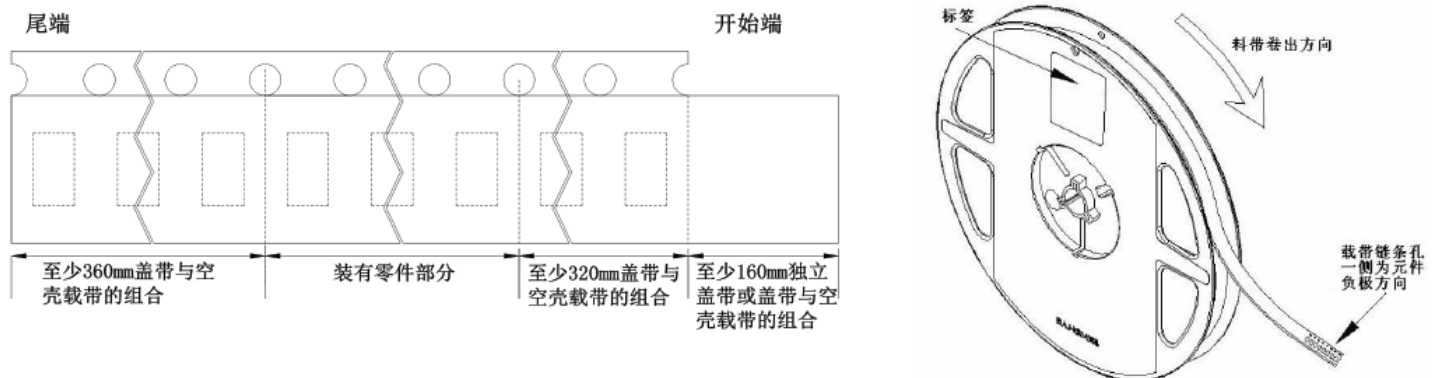

·Guideline for soldering

1. Hand Soldering

Manual welding is recommended only for repair and heavy industry situations. A soldering iron of less than 30W is recommended to be used in Hand Soldering. Please keep the temperature of the soldering iron under 300°C while soldering. Each terminal of the LED is to go for less than 3 second and for one time only. Be careful because the damage of the product is often started at the time of the hand soldering.

2. Reflow Soldering: Use the conditions shown in the under Figure of Pb -Free Reflow Soldering

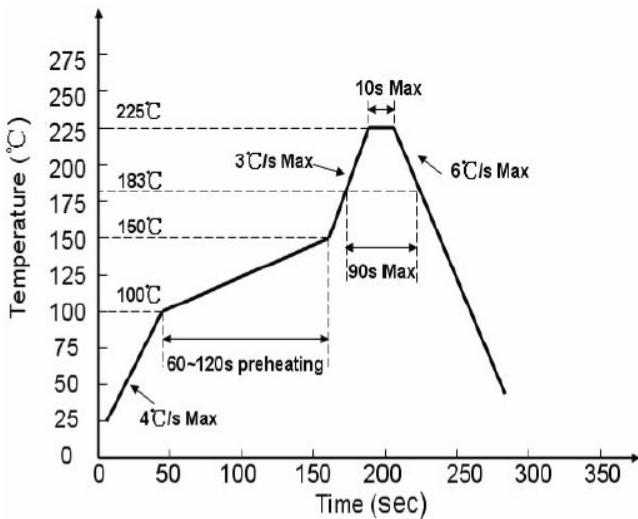

有铅制程 Lead process

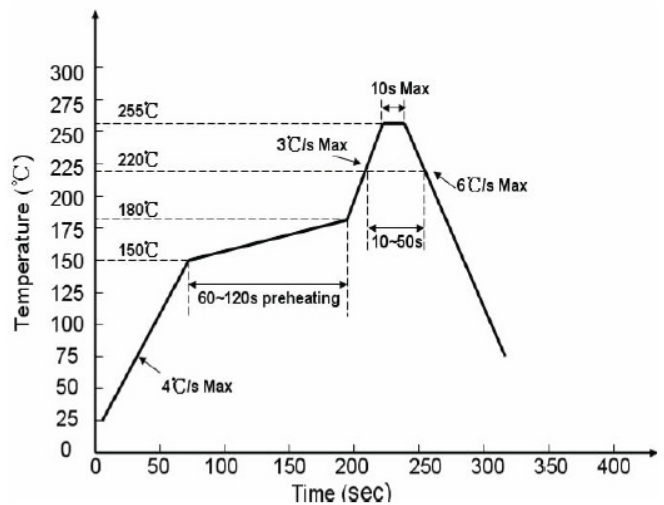

无铅制程 lead free

Reflow soldering should not be done more than two times.

Stress on the LEDs should be avoided during heating in soldering process.

After soldering, do not deal with the product before its temperature drop down to room temperature.

· Cleaning

It is recommended that alcohol be used as a solvent for cleaning after soldering. Cleaning is to go under 30°C for 3 minutes or 50°C for 30 seconds. When using other solvents, it should be confirmed beforehand whether the solvents will dissolve the package and the resin or not.

Ultrasonic cleaning is also an effective way for cleaning. But the influence of Ultrasonic cleaning on LED depends on factors such as ultrasonic power. Generally, the ultrasonic power should not be higher than 300W. Before cleaning, a pretest should be done to confirm whether any damage to LEDs will occur.

Note: This general guideline may not apply to all PCB designs and configurations of all soldering equipment. The techniques in practice is influenced by many factors, it should be specialized base on the PCB designs and configurations of the soldering equipment..

•Storage

Moisture proof and anti-electrostatic package with moisture absorbent material is used, to keep moisture to a minimum. Before opening the package, the product should be kept at 30°C or less and humidity less than 60% RH, and be used within a year.

After opening the package, the product should be stored at 30°C or less and humidity less than 10%RH, and be soldered within 168 hours (7 days). It is recommended that the product be operated at the workshop condition of 30°C or less and humidity less than 60%RH.

If the moisture absorbent material has fade away or the LEDs have exceeded the storage time, baking treatment should be performed based on the following condition: (60±5)°C for 24 hours.

•Static Electricity

Static electricity or surge voltage damages the LEDs. Damaged LEDs will show some unusual characteristic such as the forward voltage becomes lower, or the LEDs do not light at the low current. Even not light.

All devices, equipment and machinery must be properly grounded. At the same time, it is recommended that wrist bands or anti-electrostatic gloves, anti-electrostatic containers be used when dealing with the LEDs.

•Design Consideration

In designing a circuit, the current through each LED must not exceed the absolute maximum rating specified for each LED. In the meanwhile, resistors for protection should be applied, otherwise slight voltage shift will cause big current change, burn out may happen.

It is recommended to use Circuit A which regulates the current flowing through each LED rather than Circuit B. When driving LEDs with a constant voltage in Circuit B, the current through the LEDs may vary due to the variation in Forward Voltage (VF) of the LEDs. In the worst case, some LED may be subjected to stresses in excess of the Absolute Maximum Rating.

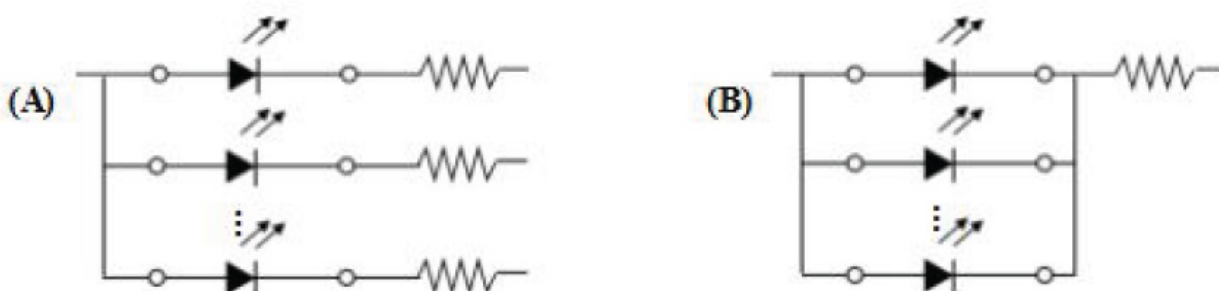

Thermal Design is paramount importance because heat generation may result in the Characteristics decline, such as brightness decreased, Color changed and so on. Please consider the heat generation of the LEDs when making the system design.

·Others

When handling the product, touching the encapsulate with bare hands will not only contaminate its surface, But also affect on its optical characteristics. Excessive force to the encapsulate might result in catastrophic failure of the LEDs due to die breakage or wire deformation. For this reason, please do not put excessive stress on LEDs, especially when the LEDs are heated such as during Reflow Soldering.

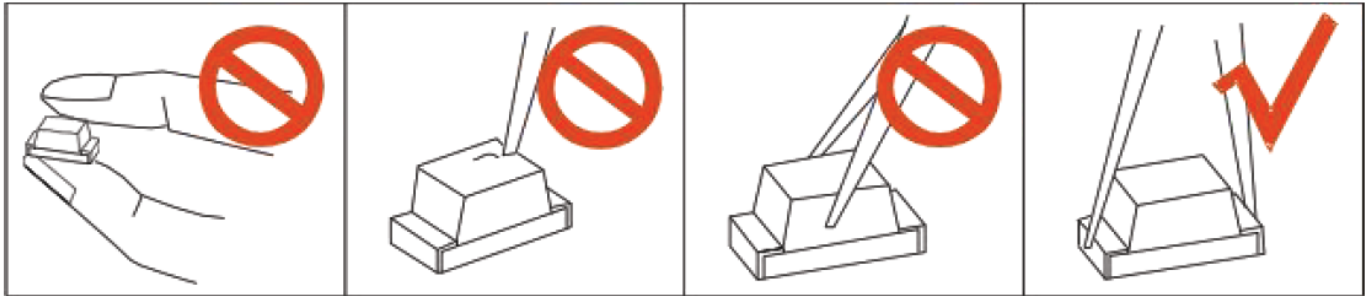

The epoxy resin of encapsulate is fragile, so please avoid scratch or friction over the epoxy resin surface. While handling the product with tweezers, do not hold by the epoxy resin, be careful.

·Safety Advice for Human Eyes

Viewing direct to the light emitting center of the LEDs, especially those of great Luminous Intensity, will cause great hazard to human eyes. Please be careful.