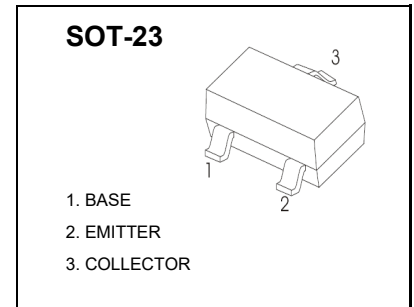

SOT-23 Plastic-Encapsulate Transistors
FEATURE

- Ideally suited for automatic insertion
- Epitaxial planar die construction
- Complementary NPN type available(TKBC817)

MAXIMUM RATINGS ($T_a=25^{\circ}\text{C}$ unless otherwise noted)

Symbol	Parameter	Value	Unit
V_{CBO}	Collector-Base Voltage	-50	V
V_{CEO}	Collector-Emitter Voltage	-45	V
V_{EBO}	Emitter-Base Voltage	-5	V
I_C	Collector Current	-500	mA
P_C	Collector Power Dissipation	300	mW
$R_{\theta JA}$	Thermal Resistance From Junction To Ambient	417	$^{\circ}\text{C}/\text{W}$
T_j	Junction Temperature	150	$^{\circ}\text{C}$
T_{stg}	Storage Temperature	-55 ~ +150	$^{\circ}\text{C}$

ELECTRICAL CHARACTERISTICS ($T_a=25^{\circ}\text{C}$ unless otherwise specified)

Parameter	Symbol	Test conditions	Min	Max	Unit
Collector-base breakdown voltage	V_{CBO}	$I_C = -10\mu\text{A}$, $I_E = 0$	-5.0		V
Collector-emitter breakdown voltage	V_{CEO}	$I_C = -10\text{mA}$, $I_B = 0$	-4.5		V
Emitter-base breakdown voltage	V_{EBO}	$I_E = -1\mu\text{A}$, $I_C = 0$	-5		V
Collector cut-off current	I_{CBO}	$V_{CB} = -45\text{V}$, $I_E = 0$		-0.1	μA
Emitter cut-off current	I_{EBO}	$V_{EB} = -4\text{V}$, $I_C = 0$		-0.1	μA
DC current gain	$h_{FE(1)}$	$V_{CE} = -1\text{V}$, $I_C = -100\text{mA}$	100	600	
	$h_{FE(2)}$	$V_{CE} = -1\text{V}$, $I_C = -500\text{mA}$	40		
Collector-emitter saturation voltage	$V_{CE(sat)}$	$I_C = -500\text{mA}$, $I_B = -50\text{mA}$		-0.7	V
Base-emitter saturation voltage	$V_{BE(sat)}$	$I_C = -500\text{mA}$, $I_B = -50\text{mA}$		-1.2	V
Transition frequency	f_T	$V_{CE} = -5\text{V}$, $I_C = -10\text{mA}$ $f = 100\text{MHz}$	100		MHz

CLASSIFICATION OF $h_{FE(1)}$

Rank	BC807-16	BC807-25	BC807-40
Range	100-250	160-400	250-600
Marking	5A	5B	5C

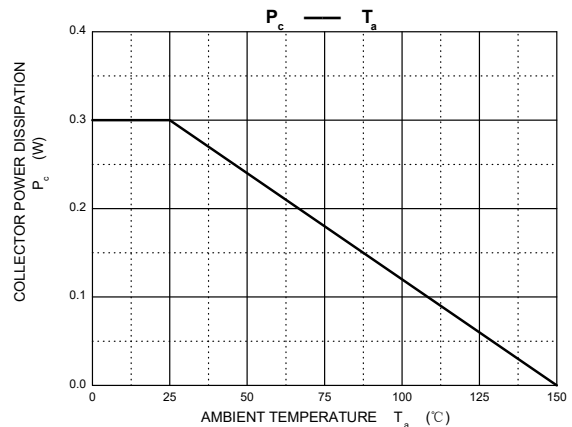
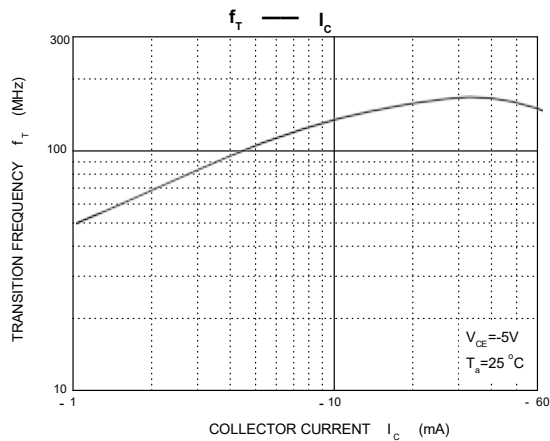
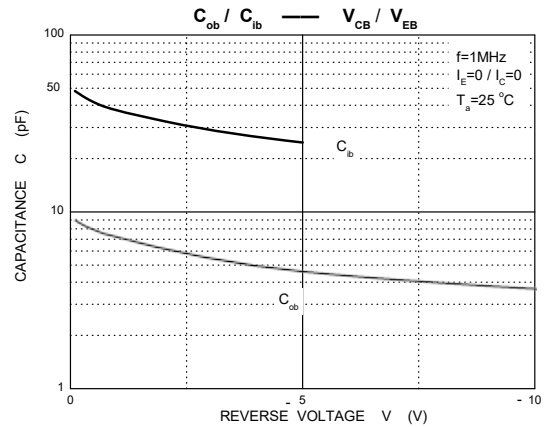
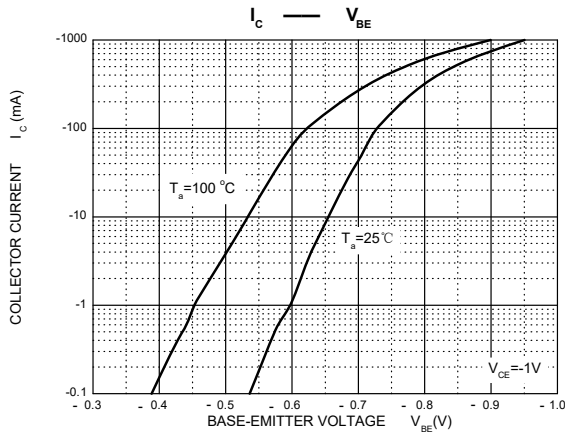
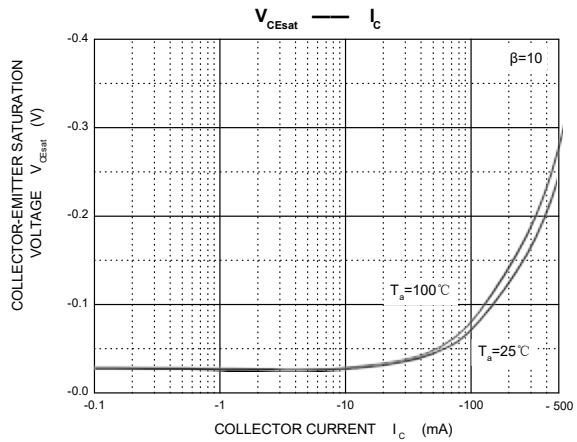
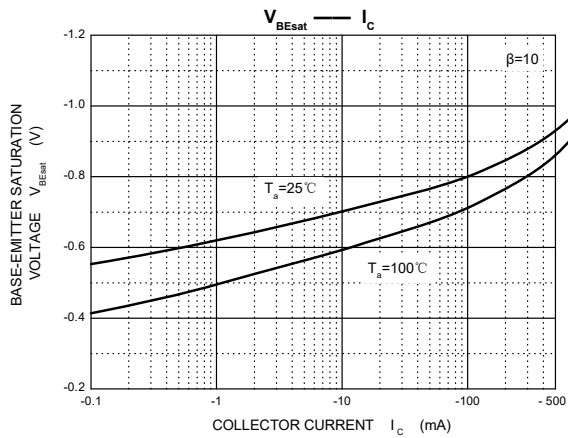
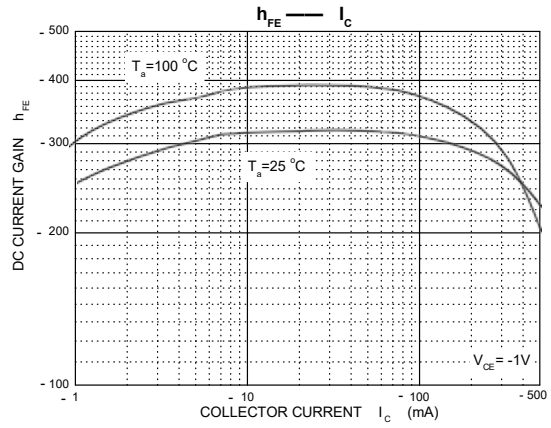
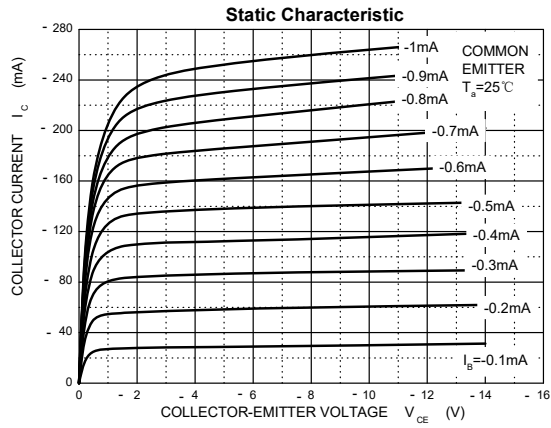
Typical Characteristics

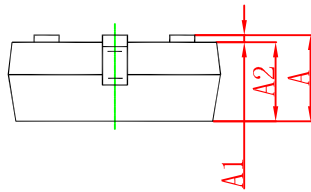
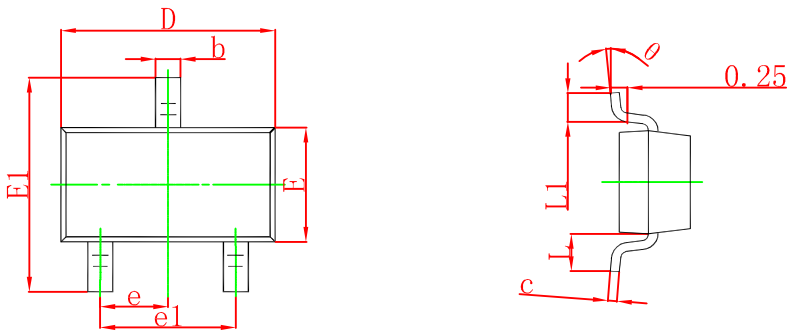

Symbol	Dimensions In Millimeters		Dimensions In Inches	
	Min	Max	Min	Max
A	0.900	1.150	0.035	0.045
A1	0.000	0.100	0.000	0.004
A2	0.900	1.050	0.035	0.041
b	0.300	0.500	0.012	0.020
c	0.080	0.150	0.003	0.006
D	2.800	3.000	0.110	0.118
E	1.200	1.400	0.047	0.055
E1	2.250	2.550	0.089	0.100
e	0.950 TYP		0.037 TYP	
e1	1.800	2.000	0.071	0.079
L	0.550 REF		0.022 REF	
L1	0.300	0.500	0.012	0.020
θ	0°	8°	0°	8°

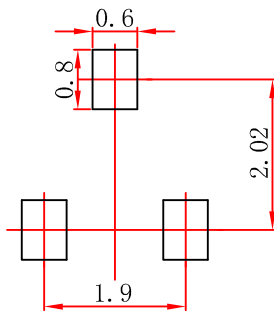
SOT-23 Suggested Pad Layout

Note:

1. Controlling dimension: in millimeters.
2. General tolerance: $\pm 0.05\text{mm}$.
3. The pad layout is for reference purposes only.