

Features

- Diffused Junction
- Low Forward Voltage Drop
- High Current Capability
- High Reliability
- High Surge Current Capability

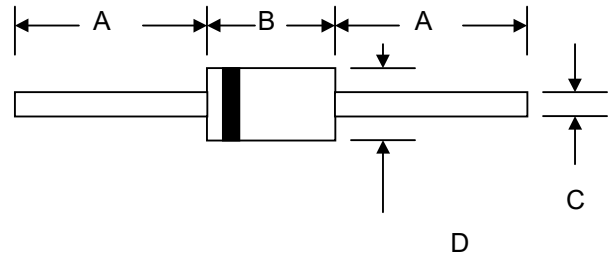

Mechanical Data

- Case: Molded Plastic
- Terminals: Plated Leads Solderable per MIL-STD-202, Method 208
- Polarity: Cathode Band
- Weight: 0.40 grams (approx.)
- Mounting Position: Any
- Marking: Type Number
- **Lead Free: For RoHS / Lead Free Version**

DO-15		
Dim	Min	Max
A	24.5	—
B	5.50	7.62
C	0.60	0.80
D	2.60	3.60
All Dimensions in mm		

Maximum Ratings and Electrical Characteristics @ $T_A=25^\circ\text{C}$ unless otherwise specified

Single Phase, half wave, 60Hz, resistive or inductive load.
For capacitive load, derate current by 20%.

Characteristic	Symbol	SF21	SF22	SF23	SF24	SF25	SF26	SF27	SF28	Unit
Peak Repetitive Reverse Voltage	V_{RRM}									
Working Peak Reverse Voltage	V_{RWM}	50	100	150	200	300	400	500	600	V
DC Blocking Voltage	V_R									
RMS Reverse Voltage	$V_{R(RMS)}$	35	70	105	140	210	280	350	420	V
Average Rectified Output Current (Note 1) @ $T_A = 55^\circ\text{C}$	I_O	2.0								A
Non-Repetitive Peak Forward Surge Current 8.3ms Single half sine-wave superimposed on rated load (JEDEC Method)	I_{FSM}	50								A
Forward Voltage @ $I_F = 2.0\text{A}$	V_{FM}	0.95			1.30		1.70			V
Peak Reverse Current @ $T_A = 25^\circ\text{C}$ At Rated DC Blocking Voltage @ $T_A = 100^\circ\text{C}$	I_{RM}	5.0				100				μA
Reverse Recovery Time (Note 2)	t_{rr}	35								nS
Typical Junction Capacitance (Note 3)	C_j	40				30				pF
Operating Temperature Range	T_j	-65 to +150								$^\circ\text{C}$
Storage Temperature Range	T_{STG}	-65 to +150								$^\circ\text{C}$

- Note: 1. Leads maintained at ambient temperature at a distance of 9.5mm from the case
2. Measured with $I_F = 0.5\text{A}$, $I_R = 1.0\text{A}$, $I_{RR} = 0.25\text{A}$. See figure 5.
3. Measured at 1.0 MHz and applied reverse voltage of 4.0V D.C.

2.0A SUPERFAST RECTIFIER

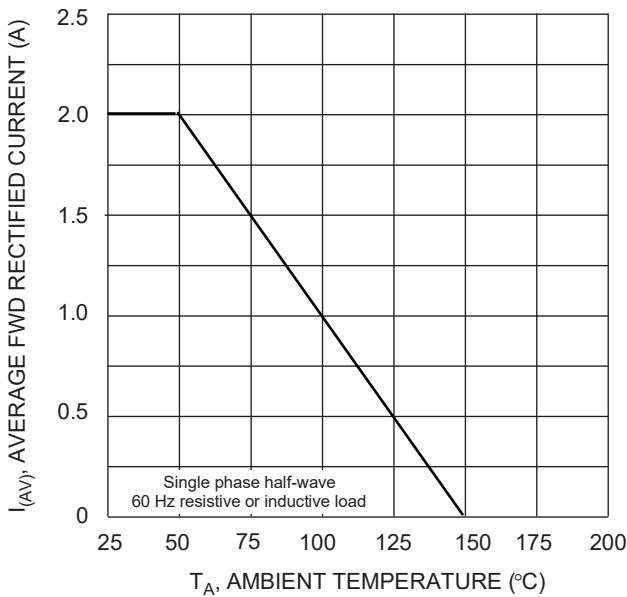

Fig. 1 Forward Current Derating Curve

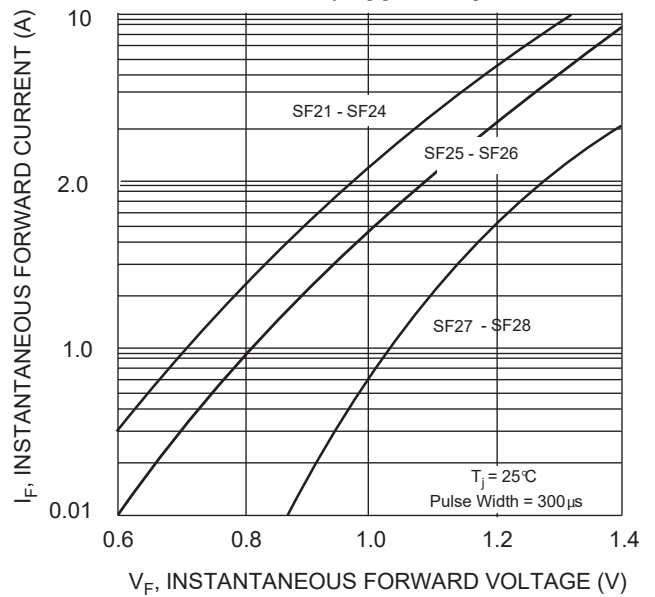

Fig. 2 Typical Forward Characteristics

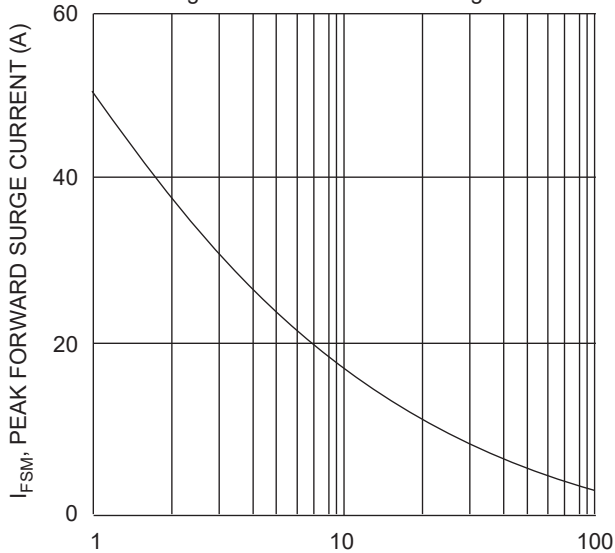

Fig. 3 Peak Forward Surge Current

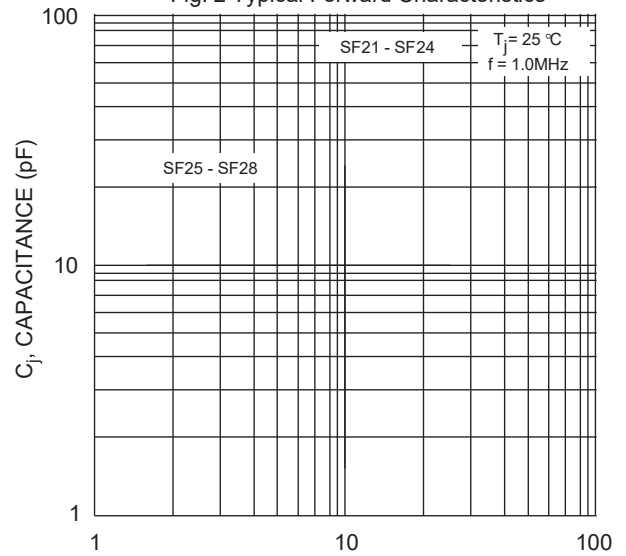
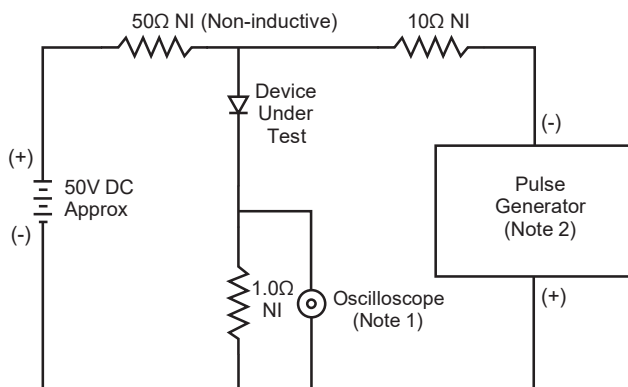

Fig. 4 Typical Junction Capacitance



- Notes:
1. Rise Time = 7.0ns max. Input Impedance = 1.0MΩ/22pF.
 2. Rise Time = 10ns max. Input Impedance = 50Ω.

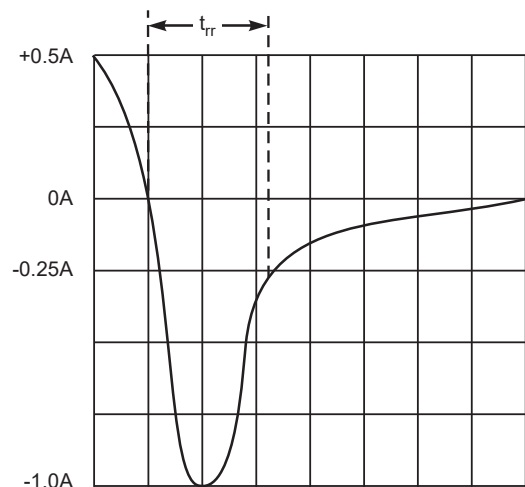

Fig. 5 Reverse Recovery Time Characteristic and Test Circuit