

**Surface Mount Schottky Barrier Rectifier**  
**Reverse Voltage - 20 to 200 V**  
**Forward Current - 3 A**

**FEATURES**

- Metal silicon junction, majority carrier conduction
- For surface mounted applications
- Low power loss, high efficiency
- High forward surge current capability
- For use in low voltage, high frequency inverters, free wheeling, and polarity protection applications

**MECHANICAL DATA**

- Case: SMB
- Terminals: Solderable per MIL-STD-750, Method 2026
- Approx. Weight: 95m g (0.0034oz )

**PINNING**

PIN	DESCRIPTION
1	Cathode
2	Anode

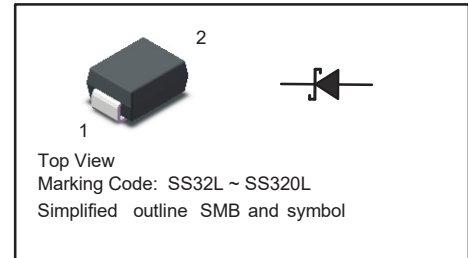

**Maximum Ratings and Electrical characteristics**

Ratings at 25 °C ambient temperature unless otherwise specified.

Single phase half-wave 60 Hz, resistive or inductive load, for capacitive load current derate by 20 %.

Parameter	Symbols	STPS3L20U	STPS3L40U	STPS3L60U	STPS3L80U	STPS3L100U	STPS3L120U	STPS3L150U	STPS3L200U	Units	
Maximum Repetitive Peak Reverse Voltage	$V_{RRM}$	20	40	60	80	100	120	150	200	V	
Maximum RMS voltage	$V_{RMS}$	14	28	42	56	70	84	105	140	V	
Maximum DC Blocking Voltage	$V_{DC}$	20	40	60	80	100	120	150	200	V	
Maximum Average Forward Rectified Current	$I_{F(AV)}$	3.0								A	
Peak Forward Surge Current, 8.3ms Single Half Sine-wave Superimposed on Rated Load (JEDEC method)	$I_{FSM}$	80								A	
Max Instantaneous Forward Voltage at 3 A	$V_F$	0.55		0.62		0.85		0.95		V	
Maximum DC Reverse Current at Rated DC Reverse Voltage $T_a = 25\text{ }^\circ\text{C}$ $T_a = 100\text{ }^\circ\text{C}$	$I_R$	0.5			0.3				5	3	mA
Typical Junction Capacitance <sup>(1)</sup>	$C_j$	450			400						
Typical Thermal Resistance <sup>(2)</sup>	$R_{\theta JA}$	60								$^\circ\text{C/W}$	
Operating Junction Temperature Range	$T_j$	-55 ~ +150								$^\circ\text{C}$	
Storage Temperature Range	$T_{stg}$	-55 ~ +150								$^\circ\text{C}$	

(1) Measured at 1 MHz and applied reverse voltage of 4 V D.C

(2) P.C.B. mounted with 2.0" X 2.0" (5 X 5 cm) copper pad areas.

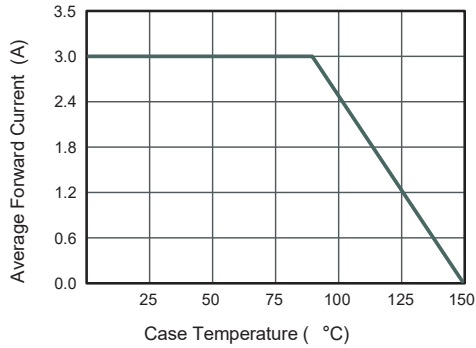
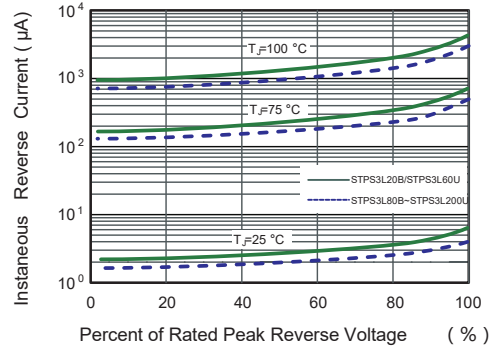
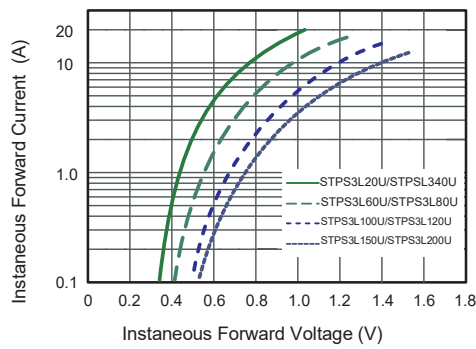
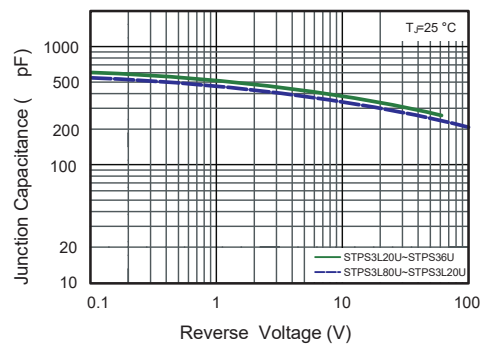
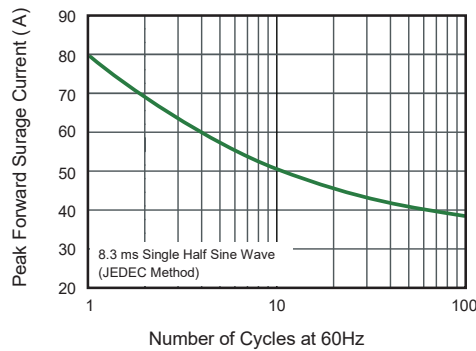
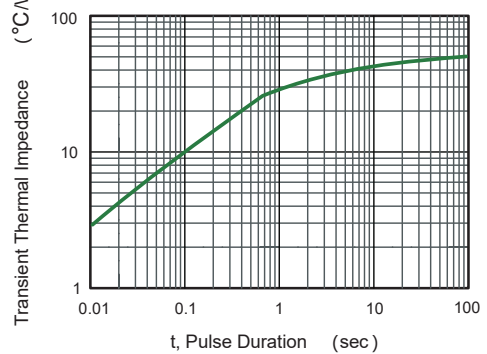
**Fig.1 Forward Current Derating Curve**

**Fig.2 Typical Reverse Characteristics**

**Fig.3 Typical Forward Characteristic**

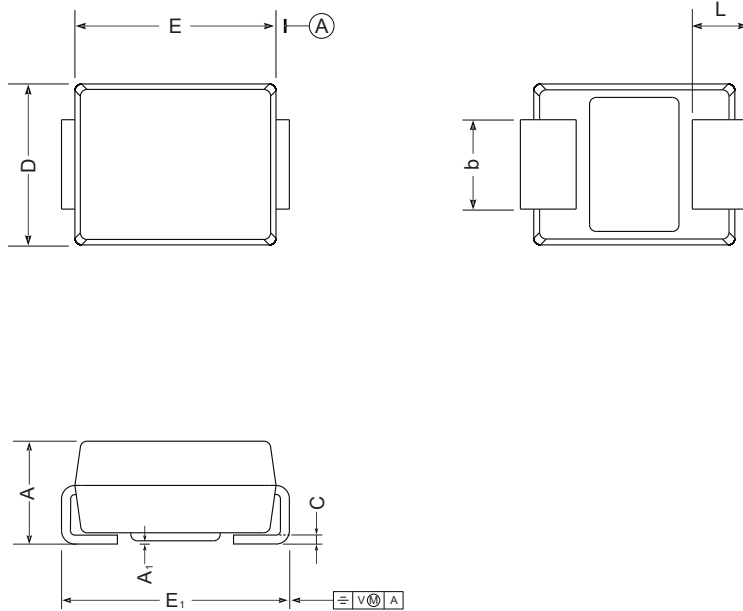
**Fig.4 Typical Junction Capacitance**

**Fig.5 Maximum Non-Repetitive Peak Forward Surge Current**

**Fig.6- Typical Transient Thermal Impedance**

## PACKAGE OUTLINE

Plastic surface mounted package; 2 leads



SMB mechanical data

UNIT		A	E	D	E <sub>1</sub>	A <sub>1</sub>	L	C	b
mm	max	2.44	4.70	3.94	5.59	0.20	1.5	0.305	2.2
	min	2.13	4.06	3.3	5.08	0.05	0.8	0.152	1.9
mil	max	96	185	155	220	7.9	59	12	87
	min	84	160	130	200	2.0	32	6	75

The recommended mounting pad size

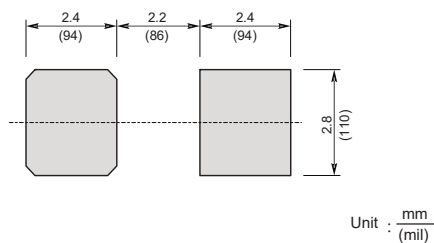

### Marking

Type number	Marking code
STPS3L20U	SS32L
STPS3L40U	SS34L
STPS3L60U	SS36L
STPS3L80U	SS38L
STPS3L100U	SS310L
STPS3L120U	SS312L
STPS3L150U	SS315L
STPS3L200U	SS320L