

**Surface Mount Superfast Recovery Rectifier**
**Reverse Voltage – 50 to 600 V**
**Forward Current – 1 A**
**FEATURES**

- For surface mounted applications
- Low profile package
- Glass Passivated Chip Junction
- Superfast reverse recovery time
- Lead free in comply with EU RoHS 2011/65/EU directives

**MECHANICAL DATA**

- Case: SMA
- Terminals: Solderable per MIL-STD-750, Method 2026
- Approx. Weight: 0.055g / 0.002oz

**PINNING**

PIN	DESCRIPTION
1	Cathode
2	Anode

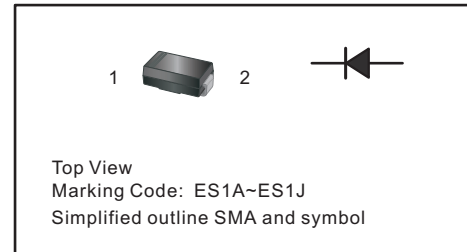

**Absolute Maximum Ratings and Characteristics**

Ratings at 25 °C ambient temperature unless otherwise specified. Single phase, half wave, 60 Hz, resistive or inductive load. For capacitive load, derate current by 20%.

Parameter	Symbols	HS1A	HS1B	HS1C	HS1D	HS1E	HS1G	HS1J	Units
		ES1A	ES1B	ES1C	ES1D	ES1E	ES1G	ES1J	
Maximum Repetitive Peak Reverse Voltage	$V_{RRM}$	50	100	150	200	300	400	600	V
Maximum RMS voltage	$V_{RMS}$	35	70	105	140	210	280	420	V
Maximum DC Blocking Voltage	$V_{DC}$	50	100	150	200	300	400	600	V
Maximum Average Forward Rectified Current	$I_{F(AV)}$	1							A
Peak Forward Surge Current 8.3 ms Single Half Sine Wave Superimposed on Rated Load (JEDEC Method)	$I_{FSM}$	30							A
Maximum Forward Voltage at 1 A	$V_F$	1				1.25		1.70	V
Maximum DC Reverse Current at Rated DC Blocking Voltage $T_a = 25\text{ °C}$ $T_a = 125\text{ °C}$	$I_R$	5 100							$\mu\text{A}$
Typical Junction Capacitance at $V_R=4\text{V}$ , $f=1\text{MHz}$	$C_j$	15							pF
Maximum Reverse Recovery Time <sup>(1)</sup>	$t_{rr}$	35							ns
Typical Thermal Resistance <sup>(2)</sup>	$R_{\theta JA}$	75							°C/W
Operating and Storage Temperature Range	$T_j, T_{stg}$	-55 ~ +150							°C

(1) Measured with  $I_F = 0.5\text{ A}$ ,  $I_R = 1\text{ A}$ ,  $I_{rr} = 0.25\text{ A}$ .

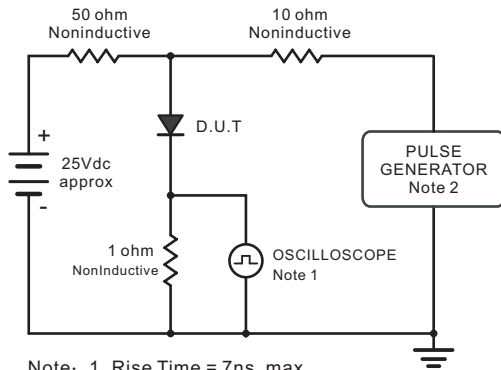
(2) P.C.B. mounted with 1.0 X 1.0" (2.54 X 2.54 cm) copper pad areas.

**Fig.1 Reverse Recovery Time Characteristic And Test Circuit Diagram**

Note: 1. Rise Time = 7ns, max.  
 Input Impedance = 1megohm, 22pF.  
 2. Rise Time = 10ns, max.  
 Source Impedance = 50 ohms.

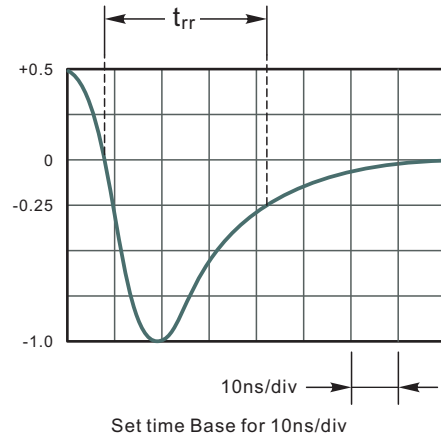
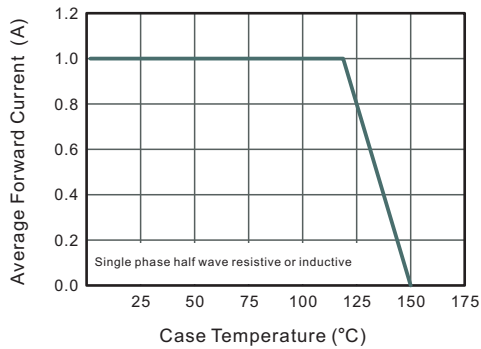
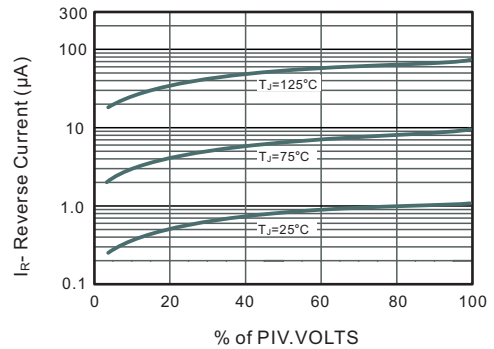
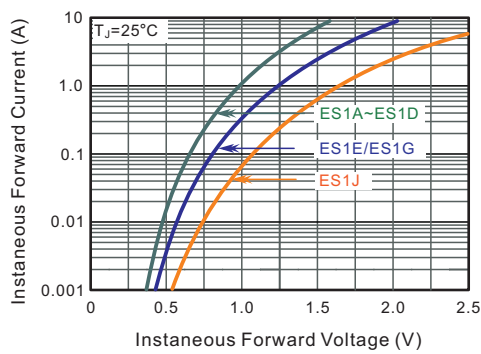
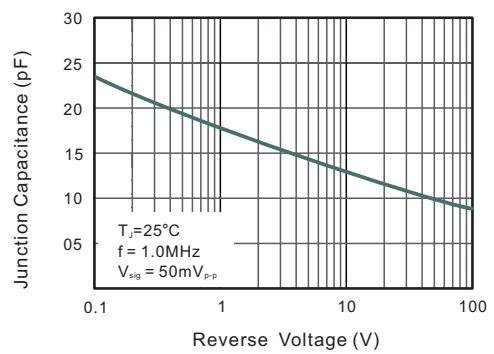
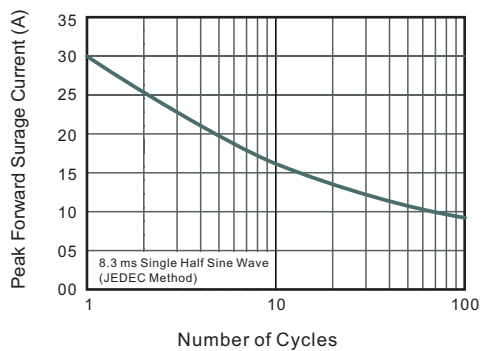
**Fig.2 Maximum Average Forward Current Rating**

**Fig.3 Typical Reverse Characteristics**

**Fig.4 Typical Forward Characteristics**

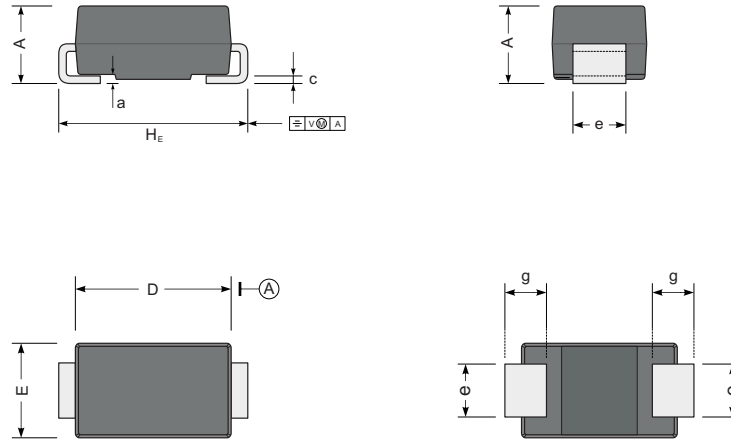
**Fig.5 Typical Junction Capacitance**

**Fig.6 Maximum Non-Repetitive Peak Forward Surge Current**

## PACKAGE OUTLINE

Plastic surface mounted package; 2 leads



UNIT		A	D	E	H <sub>E</sub>	c	e	g	a
mm	max	2.2	4.5	2.7	5.2	0.31	1.6	1.5	0.3
	min	1.9	4.0	2.3	4.7	0.15	1.3	0.9	
mil	max	87	181	106	205	12	63	59	12
	min	75	157	91	185	6	51	35	

### The recommended mounting pad size

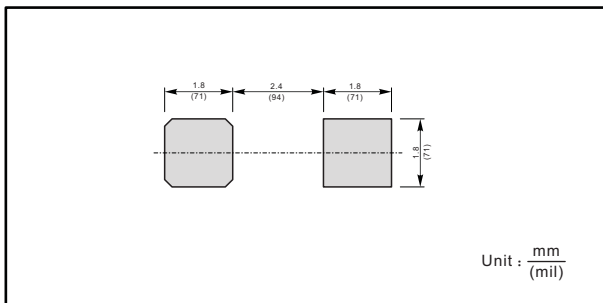

### Marking

Type number	Marking code
HS1A ES1A	ES1A
HS1B ES1B	ES1B
HS1C ES1C	ES1C
HS1D ES1D	ES1D
HS1E ES1E	ES1E
HS1G ES1G	ES1G
HS1J ES1J	ES1J