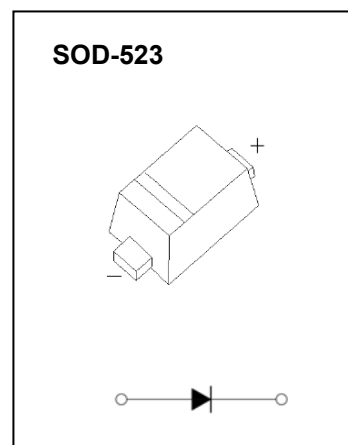

SOD- 523 Plastic-Encapsulate Diodes
FEATURES

- Small Package
- Low Reverse Current
- Fast Switching Speed
- Surface Mount Package Ideally Suited for Automatic Insertion

MARKING: 61

MAXIMUM RATINGS ($T_a=25^{\circ}\text{C}$ unless otherwise noted)

Symbol	Parameter	Value	Unit
V_{RM}	Non-Repetitive Peak Reverse Voltage	100	V
V_{RRM}	Peak Repetitive Reverse Voltage	75	V
V_{RWM}	Working Peak Reverse Voltage		
$V_{R(RMS)}$	RMS Reverse Voltage	53	V
I_o	Average Rectified Output Current	250	mA
I_{FSM}	Non-repetitive Peak Forward Surge Current @ $t=8.3\text{ms}$	2.0	A
P_D	Power Dissipation	150	mW
$R_{\theta JA}$	Thermal Resistance from Junction to Ambient	833	$^{\circ}\text{C/W}$
T_J, T_{stg}	Operation Junction and Storage Temperature Range	-55~+150	$^{\circ}\text{C}$

ELECTRICAL CHARACTERISTICS($T_a=25^{\circ}\text{C}$ unless otherwise specified)

Parameter	Symbol	Test conditions	Min	Typ	Max	Unit
Reverse voltage	$V_{(BR)}$	$I_R=100\mu\text{A}$	75			V
Reverse current	I_R	$V_R=25\text{V}$			30	nA
		$V_R=75\text{V}$			1	μA
Forward voltage	V_F	$I_F=1\text{mA}$			0.715	V
		$I_F=10\text{mA}$			0.855	V
		$I_F=50\text{mA}$			1	V
		$I_F=150\text{mA}$			1.25	V
Total capacitance	C_{tot}	$V_R=0\text{V}, f=1\text{MHz}$			1	pF
Reverse recovery time	t_{rr}	$I_F=I_R=10\text{mA}, I_{rr}=0.1*I_R, R_L=100\Omega$			4	ns

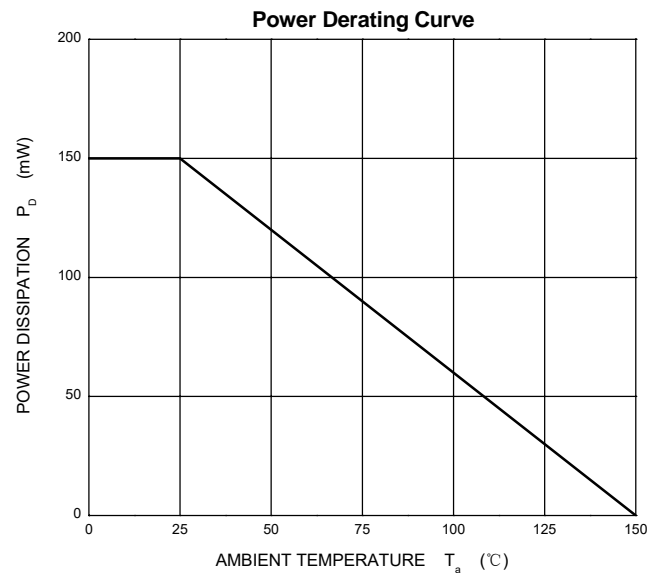
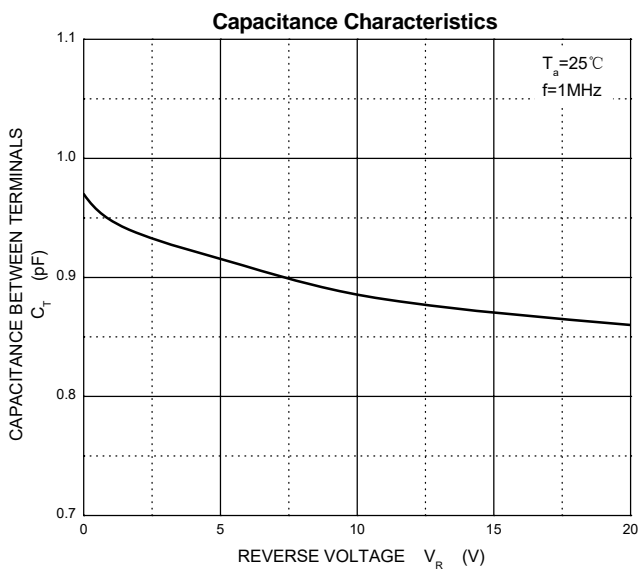
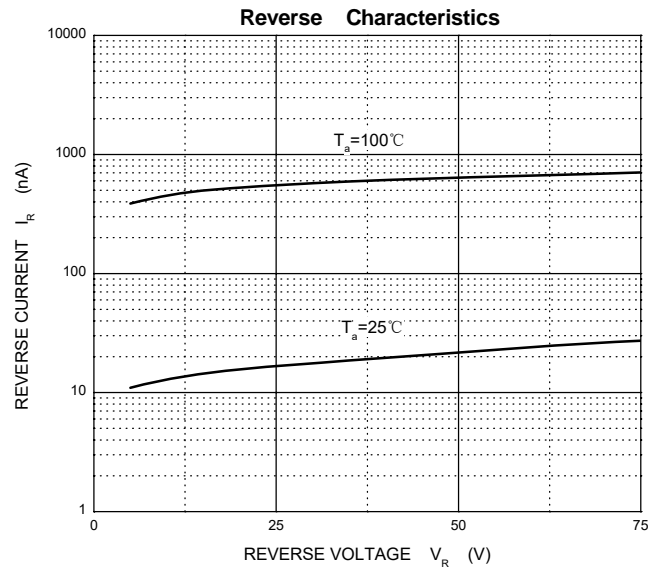
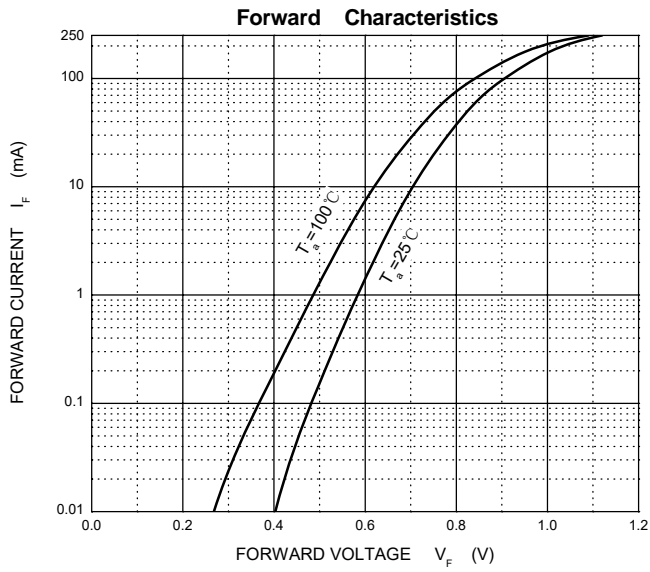
Typical Characteristics



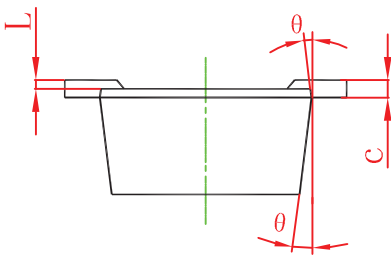
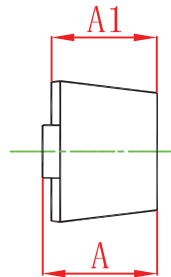
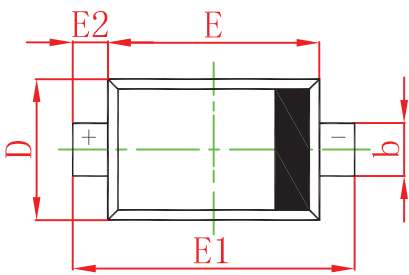

Symbol	Dimensions In Millimeters		Dimensions In Inches	
	Min	Max	Min	Max
A	0.510	0.770	0.020	0.031
A1	0.500	0.700	0.020	0.028
b	0.250	0.350	0.010	0.014
c	0.080	0.150	0.003	0.006
D	0.750	0.850	0.030	0.033
E	1.100	1.300	0.043	0.051
E1	1.500	1.700	0.059	0.067
E2	0.200 REF		0.008 REF	
L	0.010	0.070	0.001	0.003
θ	7° REF		7° REF	

SOD-523 Suggested Pad Layout

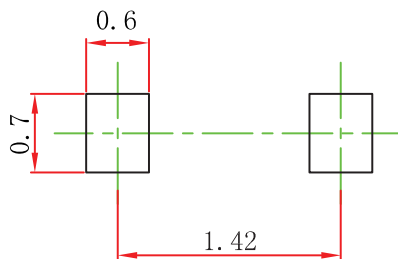

Note:

1. Controlling dimension: in millimeters.
2. General tolerance: $\pm 0.05\text{mm}$.
3. The pad layout is for reference purposes only.