

Surface Mount Schottky Barrier Rectifier
 Reverse Voltage - 20 to 200V
 Forward Current - 2.0A

FEATURES

- Metal silicon junction, majority carrier conduction
- For surface mounted applications
- Low power loss, high efficiency
- High forward surge current capability
- For use in low voltage, high frequency inverters, free wheeling, and polarity protection applications

MECHANICAL DATA

- Case : SMB
- Terminals: Solderable per MIL-STD-750, Method 2026
- Approx. Weight : 0.095g / 0.003oz

PINNING

PIN	DESCRIPTION
1	Cathode
2	Anode

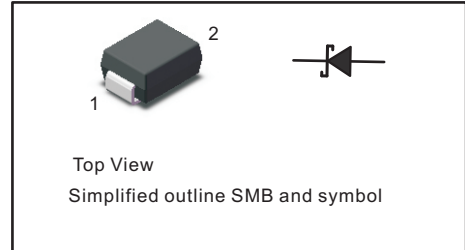

Absolute Maximum Ratings and Electrical characteristics

Ratings at 25 °C ambient temperature unless otherwise specified. Single phase, half wave, 60Hz resistive or inductive load, for capacitive load, derate by 20 %

Parameter	Symbols	MBRS120	MBRS140	MBRS160	MBRS180	MBRS1100	MBRS1120	MBRS1150	MBRS1200	Units
		SS22B	SS24B	SS26B	SS28B	SS210B	SS212B	SS215B	SS220B	
Maximum Repetitive Peak Reverse Voltage	V_{RRM}	20	40	60	80	100	120	150	200	V
Maximum RMS voltage	V_{RMS}	14	28	42	56	70	84	105	140	V
Maximum DC Blocking Voltage	V_{DC}	20	40	60	80	100	120	150	200	V
Maximum Average Forward Rectified Current	$I_{F(AV)}$	2.0								A
Peak Forward Surge Current, 8.3ms Single Half Sine-wave Superimposed on Rated Load (JEDEC method)	I_{FSM}	55				45				A
Max Instantaneous Forward Voltage at 2 A	V_F	0.55	0.70		0.85		0.95		V	
Maximum DC Reverse Current $T_a = 25^\circ\text{C}$ at Rated DC Reverse Voltage $T_a = 100^\circ\text{C}$	I_R	0.5 5			0.3 3				mA	
Typical Junction Capacitance ⁽¹⁾	C_j	220			110				pF	
Typical Thermal Resistance ⁽²⁾	$R_{\theta JA}$	60								°C/W
Operating Junction Temperature Range	T_j	-55 ~ +125								°C
Storage Temperature Range	T_{stg}	-55 ~ +150								°C

(1) Measured at 1 MHz and applied reverse voltage of 4 V D.C

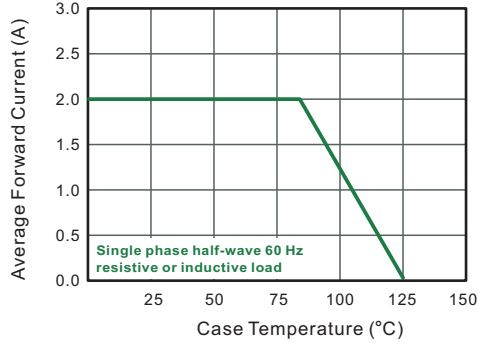
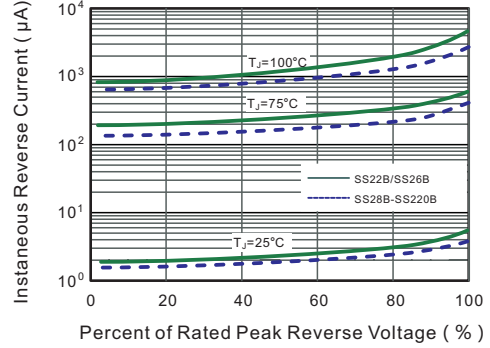
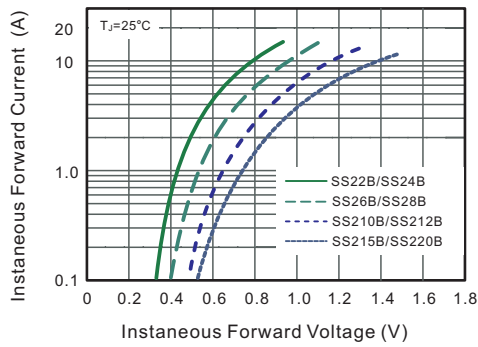
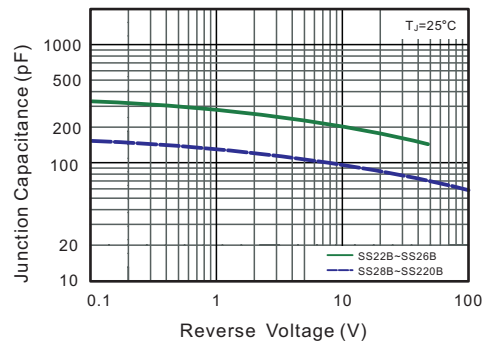
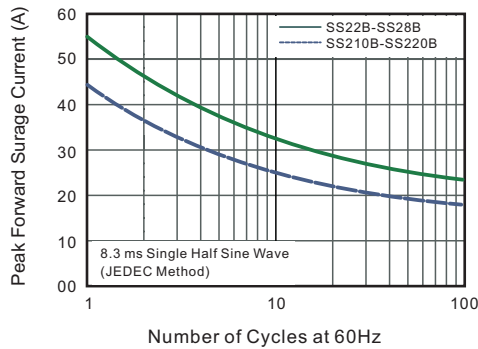
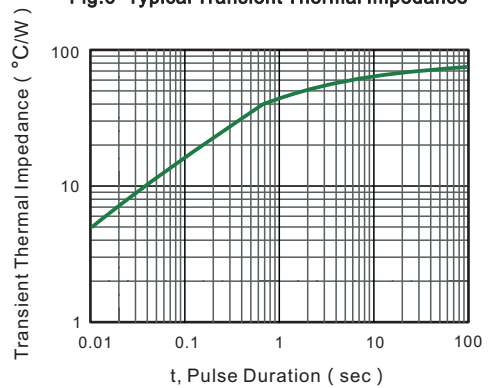
(2) P.C.B. mounted with 2.0" X 2.0" (5 X 5 cm) copper pad areas.

Fig.1 Forward Current Derating Curve

Fig.2 Typical Reverse Characteristics

Fig.3 Typical Forward Characteristic

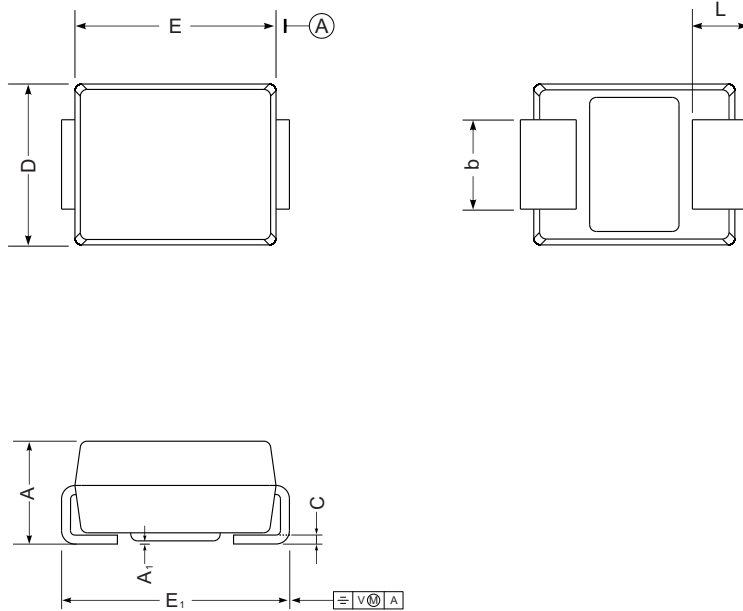
Fig.4 Typical Junction Capacitance

Fig.5 Maximum Non-Repetitive Peak Forward Surge Current

Fig.6- Typical Transient Thermal Impedance

PACKAGE OUTLINE

Plastic surface mounted package; 2 leads



SMB mechanical data

UNIT		A	E	D	E ₁	A ₁	L	C	b
mm	max	2.44	4.70	3.94	5.59	0.20	1.5	0.305	2.2
	min	2.13	4.06	3.3	5.08	0.05	0.8	0.152	1.9
mil	max	96	185	155	220	7.9	59	12	87
	min	84	160	130	200	2.0	32	6	75

The recommended mounting pad size

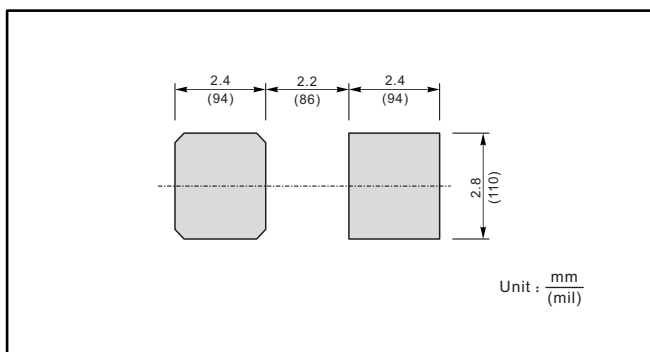

Marking

Type number	Marking code
SS22B/MBRS120	SS22
SS24B/MBRS140	SS24
SS26B/MBRS160	SS26
SS28B/MBRS180	SS28
SS210B/MBRS1100	SS210
SS212B/MBRS1120	SS212
SS215B/MBRS1150	SS215
SS220B/MBRS1200	SS220