

# SOT-23 Plastic-Encapsulate Diodes

SWITCHING DIODE

**FEATURES**

- Fast Switching Speed
- High Conductance
- For General Purpose Switching Applications

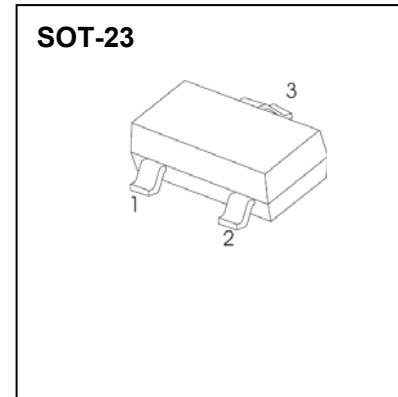

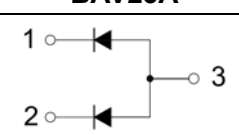
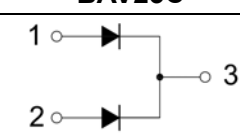
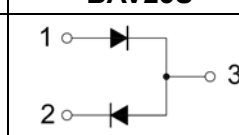
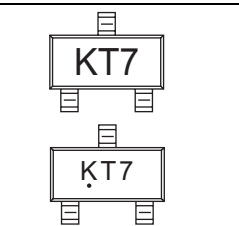
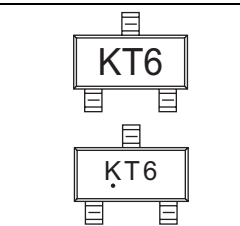
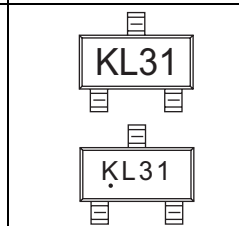
BAV23A	BAV23C	BAV23S
		
<b>MARKING: KT7</b>	<b>MARKING: KT6</b>	<b>MARKING: KL31</b>
		

Solid dot = Green molding compound device, if none, the normal device

**MAXIMUM RATINGS (  $T_a=25^\circ\text{C}$  unless otherwise noted )**

Symbol	Parameter	Value	Unit
$V_{RRM}$	Peak Repetitive Reverse Voltage	250	V
$V_{RWM}$	Working Peak Reverse Voltage		
$V_{R(RMS)}$	RMS Reverse Voltage	175	V
$I_O$	Average Rectified Output Current	225	mA
$I_{FSM}$	Non-repetitive Peak Forward Surge Current @ $t=8.3\text{ms}$	1.7	A
$P_D$	Power Dissipation	350	mW
$R_{\theta JA}$	Thermal Resistance from Junction to Ambient	357	$^\circ\text{C/W}$
$T_j$	Junction Temperature	150	$^\circ\text{C}$
$T_{stg}$	Storage Temperature	-55~+150	$^\circ\text{C}$

**ELECTRICAL CHARACTERISTICS ( $T_a=25^\circ\text{C}$  unless otherwise specified)**

Parameter	Symbol	Test conditions	Min	Typ	Max	Unit
Reverse voltage	$V_{(BR)}$	$I_R=100\mu\text{A}$	250			V
Reverse current	$I_R$	$V_R=250\text{V}$			0.1	$\mu\text{A}$
Forward voltage	$V_F$	$I_F=100\text{mA}$			1	V
		$I_F=200\text{mA}$			1.25	
Total capacitance	$C_{tot}$	$V_R=0\text{V}, f=1\text{MHz}$			5	pF
Reverse recovery time	$t_{rr}$	$I_F=I_R=30\text{mA}, I_{rr}=0.1\times I_R, R_L=100\Omega$			50	ns

Typical Characteristics

Forward Characteristics

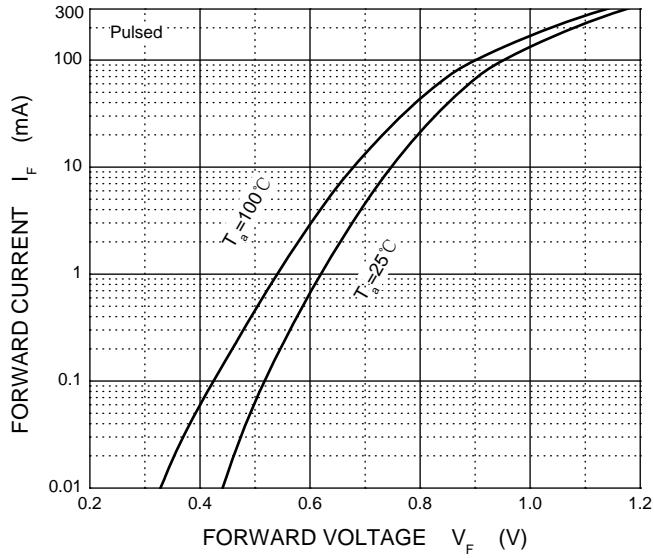

Reverse Characteristics

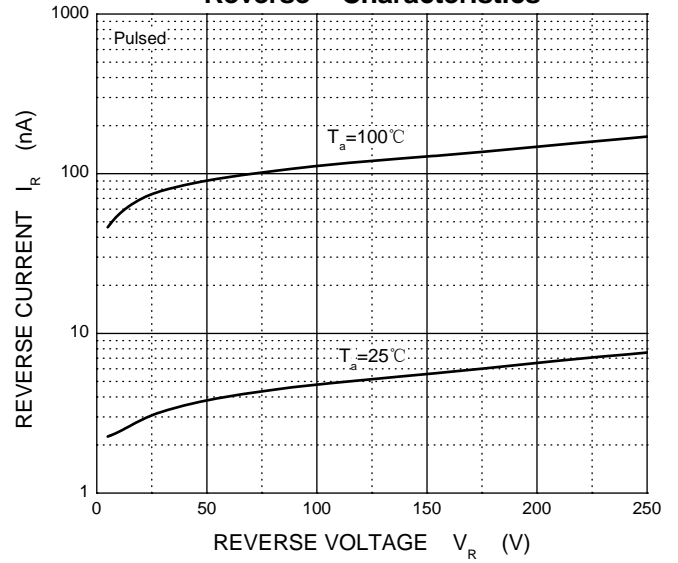

Capacitance Characteristics

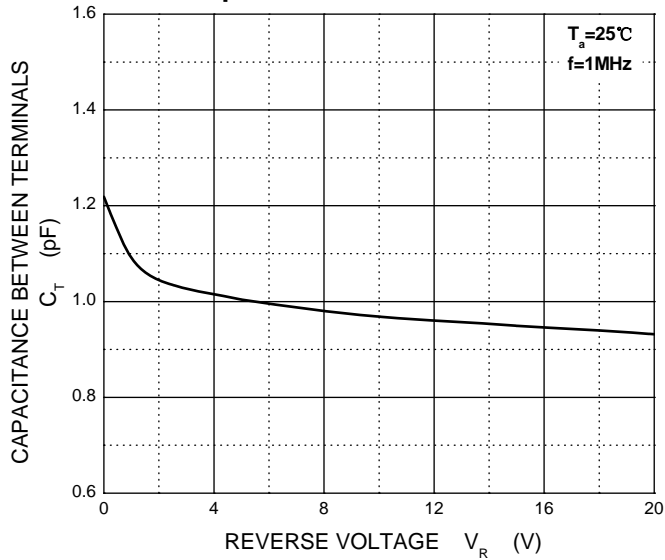

Power Derating Curve

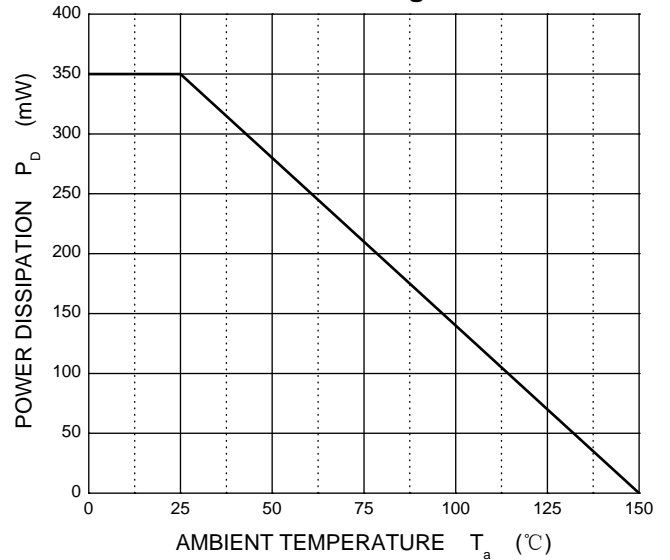

SOT-23 Package Outline Dimensions

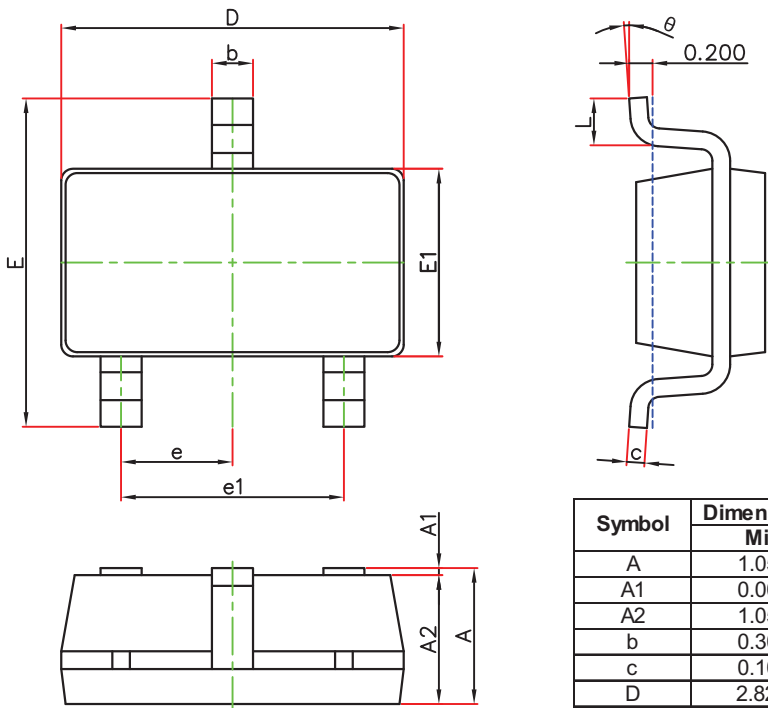

Symbol	Dimensions In Millimeters		Dimensions In Inches	
	Min.	Max.	Min.	Max.
A	1.050	1.250	0.041	0.049
A1	0.000	0.100	0.000	0.004
A2	1.050	1.150	0.041	0.045
b	0.300	0.500	0.012	0.020
c	0.100	0.200	0.004	0.008
D	2.820	3.020	0.111	0.119
E1	1.500	1.700	0.059	0.067
E	2.650	2.950	0.104	0.116
e	0.950(BSC)		0.037(BSC)	
e1	1.800	2.000	0.071	0.079
L	0.300	0.600	0.012	0.024
θ	0°	8°	0°	8°

SOT-23-3L Suggested Pad Layout

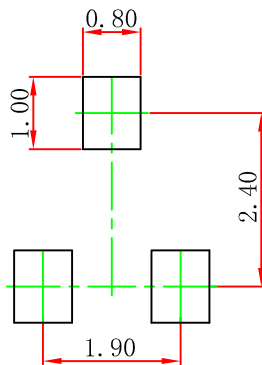

- Note:
1. Controlling dimension: in millimeters.
  2. General tolerance:  $\pm 0.05\text{mm}$ .
  3. The pad layout is for reference purposes only.